

# 1221-2GY



UPC Code: 07847723992

Country of Origin: United States - \*Eligible for ARRA funded projects



\*May include one or more globally sourced components.



## Switches and Motor Controls

### Brand Features

Leviton's Industrial Grade AC toggle switches for extra heavy-duty applications represent top-of-the-line quality and peak performance. Leviton uses the finest materials available and the highest production standards to produce industrial switches of unmatched versatility and reliability.

### Item Description

20 Amp, 120/277 Volt, Toggle Single-Pole AC Quiet Switch, Extra Heavy Duty Spec Grade, Self Grounding, Back & Side Wired - GRAY

### Technical Information

#### AC Horsepower Ratings

**HP Rating:** 1HP-120V 2HP-240V

**Max. Amperage:** 16 Amp

#### Electrical Specifications

**Amperage:** 20 Amp

**Voltage:** 120/277 VAC

**Grounding:** Self-Grounding

**Dielectric Voltage:** Withstands 1500V for 1 minute

**Overload UL20 Test:** 100 cycles of OL at 4.8 times rated current

**Temperature Rise:** Maximum 30 degrees C rise

**Endurance:** 50,000 cycles minimum

#### Environmental Specifications

**Flammability:** Rated V-2 per UL94

**Operating Temperature:** -40°C to 65°C

#### Material Specifications

**Strap Material:** .048" Thick Galvanized Steel

**Base Material:** Thermoplastic

**Toggle:** Polycarbonate

**Cover Material:** Thermoplastic

**Contact Material:** Silver Alloy

**Terminal Screws:** Brass 8-32

**Grounding Screw:** Brass 8-32

**Ground Clips:** Brass

**Color:** Gray

#### Mechanical Specifications

**Terminal ID:** Brass-Hot Black-Hot White-Neutral Green-Gnd

**Terminal Accom.:** 14-#10 AWG back wired; #14-#12 AWG side wired

**Product ID:** Ratings are permanently marked on device

**Torque Range:** 12-14 inch pounds

#### Product Features

**Color:** Gray

**Grounding:** Self Grounding

**Voltage:** 120/277 Volt

**HP Rating:** 1HP-120V 2HP-240V-277V

**Body Material:** Thermoplastic

**Strap Material:** Steel

#### Standards and Certifications

**NEMA:** WD-1 & WD-6

**ANSI:** C-73

**UL Fed Spec WS896E:** File #E7458

**UL Standard:** UL 20

**CSA C22.2 No. 111:** File #152105

**NOM:** 057

**RoHS:** Compliant

**Warranty:** 10 Year Limited

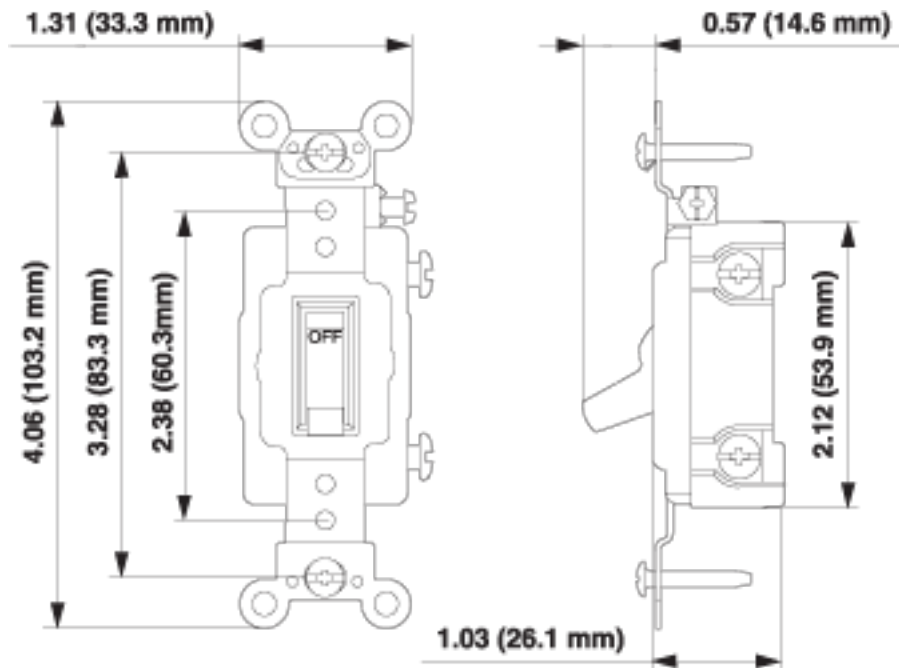

## SINGLE-POLE

### Wiring Diagram Single Pole

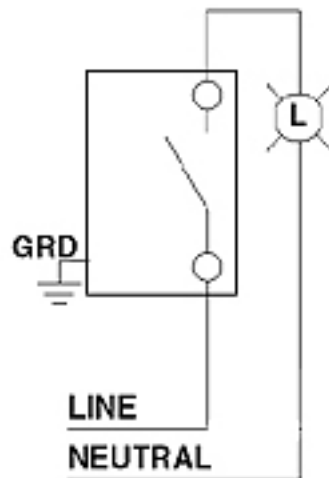

#### SPECIFICATION SUBMITTAL

JOB NAME:	CATALOG NUMBERS:	
<input type="text"/>	<input type="text"/>	<input type="text"/>
JOB NUMBER:	<input type="text"/>	<input type="text"/>

**Leviton Manufacturing Co., Inc.**

201 North Service Road, Melville, NY 11747

Telephone: 1-800-323-8920 · FAX: 1-800-832-9538 · Tech Line (8:30AM-7:30PM E.S.T. Monday-Friday): 1-800-824-3005

**Leviton Manufacturing of Canada, Ltd.**

165 Hymus Boulevard, Pointe Claire, Quebec H9R 1E9 · Telephone: 1-800-469-7890 ·

FAX: 1-800-824-3005 · [www.leviton.com/canada](http://www.leviton.com/canada)

**Leviton S. de R.L. de C.V.**

Lago Tana 43, Mexico DF, Mexico CP 11290 · Tel.: (+52)55-5082-1040 · FAX: (+52)5386-1797 · [www.leviton.com.mx](http://www.leviton.com.mx)

**Visit our Website at: [www.leviton.com](http://www.leviton.com)**

© 2012-2017 Leviton Manufacturing Co., Inc. All rights reserved. Subject to change without notice.



**Leviton has a global presence.**

If you would like to know where your local Leviton office is located please go to: [www.leviton.com/international/contacts/](http://www.leviton.com/international/contacts/)

*\*Buy American Compliant Logo -- The American Recovery And Reinvestment Act of 2009 ("ARRA") provides federal grants and loans for projects throughout the country. Section 1605 of the Act, named the "Buy American" provision, requires that certain materials and manufactured products used in projects funded by the Act be manufactured in the United States. The appearance of the Recovery Act Logo in relation to a Leviton product is only intended to reflect that such product may be used in an ARRA funded project. It does not mean that such product or Leviton is sponsored or endorsed by, or that Leviton receives funds from, the federal government or the Recovery Accountability and Transparency Board. Nothing in Leviton's use of the logo is intended to suggest anything regarding the requirements for funding under ARRA.*