

Please go to [www. quozel. com](http://www. quozel. com) for product cleaning tips. Go to the **Care + Maintenance** selection.

**Tools Required:** Flathead screwdriver, Phillips screwdriver, pliers, wire cutters, wire strippers, electrical tape, safety glasses.

**Light Source:** (2) A19 Medium Base 75W bulb Maximum, Alternate bulb (2) 19W CFL Maximum.

**Estimated Assembly Time:** 30-45 minutes

**Preparation:** Identify and inspect all parts before beginning installation. Check package content list and diagrams below to be sure all parts are present. If any parts are missing or damaged, do not attempt to assemble, install, or operate the fixture. Contact customer service for replacement parts.

**⚠ Warnings and Cautions**

Turn off electricity at circuit breaker or main fuse box before installation. Consult a licensed electrician if in doubt.

These instructions are provided for your safety. It is very important you read them completely before installing the fixture. We strongly recommend that a licensed, professional electrician perform the installation.

Disconnect fixture from power source before replacing bulbs. Make sure bulbs are given sufficient time to cool before removal. Do not subject glass parts to any shock while in operation or shattering may result.

**⚠ Care of Tiffany Style Shade**

A new tiffany lamp shade has an oil film applied to the shade that protects the tiffany shade from scratches during shipment. If the oil applied is too heavy you can remove the excess oil film with a paper towel. Gently wipe away the excess oil.

For general cleaning of tiffany shades use a gentle lemon oil-based furniture polish applied to a soft cloth and wipe gently.

If a white powder appears on the soldered joints of the tiffany shade this is a normal oxidation process. Use a small amount of lemon oil or mineral oil applied directly to oxidized areas and the soldered area will return to like new.

**Package Contents**

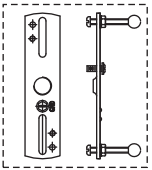

**A** Crossbar Assembly x 1

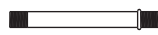

**C** Stem 3.5" L x 1



**D** Flat Washer x 1

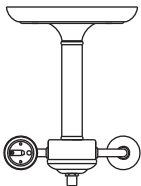

**B** Fixture Body x 1

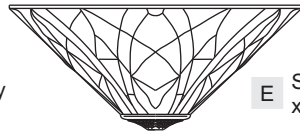

**E** Shade x 1



**F** Finial x 1

**(Step 2 Continued)**

on the Crossbar Assembly (A) by unscrewing the preassembled hex nut and lock washer and then screwing the mounting screws in or out of the crossbar until the correct length is achieved. Once the ceiling canopy is secure, remove the mounting ball and ceiling canopy and proceed to Step 3.

**STEP 3 - Wire Connections**

A. Use standard wire connectors (not included) to make all wire connections. (Connectors are not included with fixture.) Twist connectors until wires are tightly joined together. Wrap each connection with approved electrical tape and carefully stuff all the connected wires into the Outlet Box.

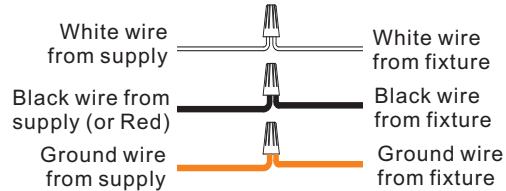

**Figure 3**

**STEP 1 - Install Crossbar Assembly**

A. Pass the supply wires through the Crossbar Assembly (A). Attach the Crossbar Assembly (A) to the Outlet Box with the head of the Green Ground Screw facing you. Secure it with Outlet Box Screws (not included). Tighten until snug.

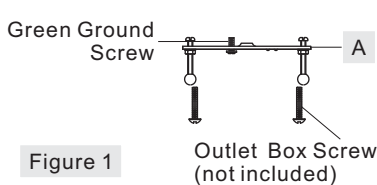
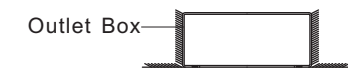

**Figure 1**

**STEP 2 - Fit Ceiling Canopy to Crossbar Assembly**

A. Remove mounting balls from the Crossbar Assembly (A). Fit the ceiling canopy of the Fixture Body (B) to the Crossbar Assembly (A) and secure with mounting balls. Note: The ceiling canopy should be snug against the ceiling and the mounting balls. If not, adjust the length of the mounting screw

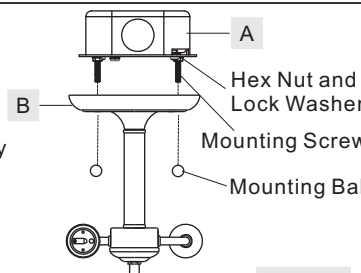

**Figure 2**

**STEP 4 - Install Fixture Body**

A. Carefully tuck all wires into the outlet box and position the ceiling canopy of the Fixture Body (B) over the outlet box. Align the holes in the ceiling canopy with the mounting screws, then attach the ceiling canopy using the previously removed mounting balls. Hand tighten until snug.

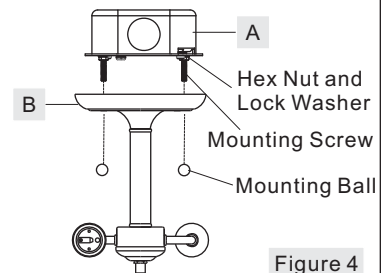

**Figure 4**

**STEP 5 - Install Shade and Bulbs**

A. Thread the beaded end of Center Stem (C) into the hex coupling underside of the Fixture Body (B). Hand tighten until snug.

**Thank you for purchasing a Quoizel product.**  
**Need assistance with parts or assembly? Call Quoizel customer service at 1-631-273-2700 or visit us on-line at [www. quozel. com](http://www. quozel. com)**

**(Step 5 Continued)**

- B. Place the Flat Washer (D) and the Shade (E) over the bottom end of the Stem (C). Secure by threading the Finial (F) onto the Stem (C). Hand tighten until snug.
- C. This fixture uses standard bulb with medium base . Maximum 75 watts. Insert bulb and screw snugly into place.

Your fixture is now assembled and ready to use. Enjoy!

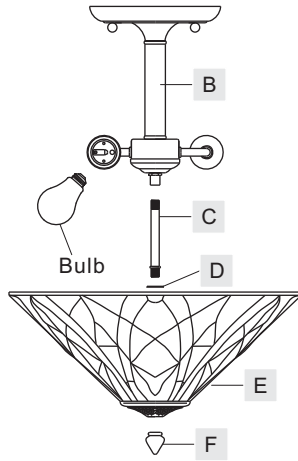
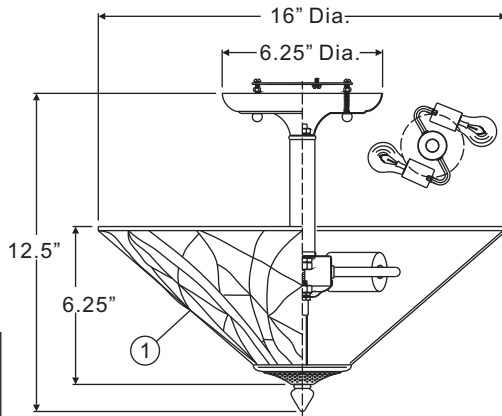
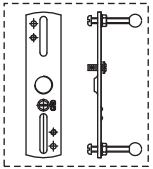

Figure 5

TFVY1716VA

FINISH: VALIANT BRONZE



NOTE: ALL DIMENSIONS ARE ROUNDED UP TO THE NEAREST 1/4"



(2) 75W Medium Base Bulbs (Not Supplied)

NO.	PART NUMBER	REPLACEMENT PART	REQ.
1	G12120SH	SHADE	1

Thank you for purchasing a Quoizel product.  
 Need assistance with parts or assembly? Call Quoizel customer service at 1-631-273-2700  
 or visit us on-line at [www.quoise.com](http://www.quoise.com)