

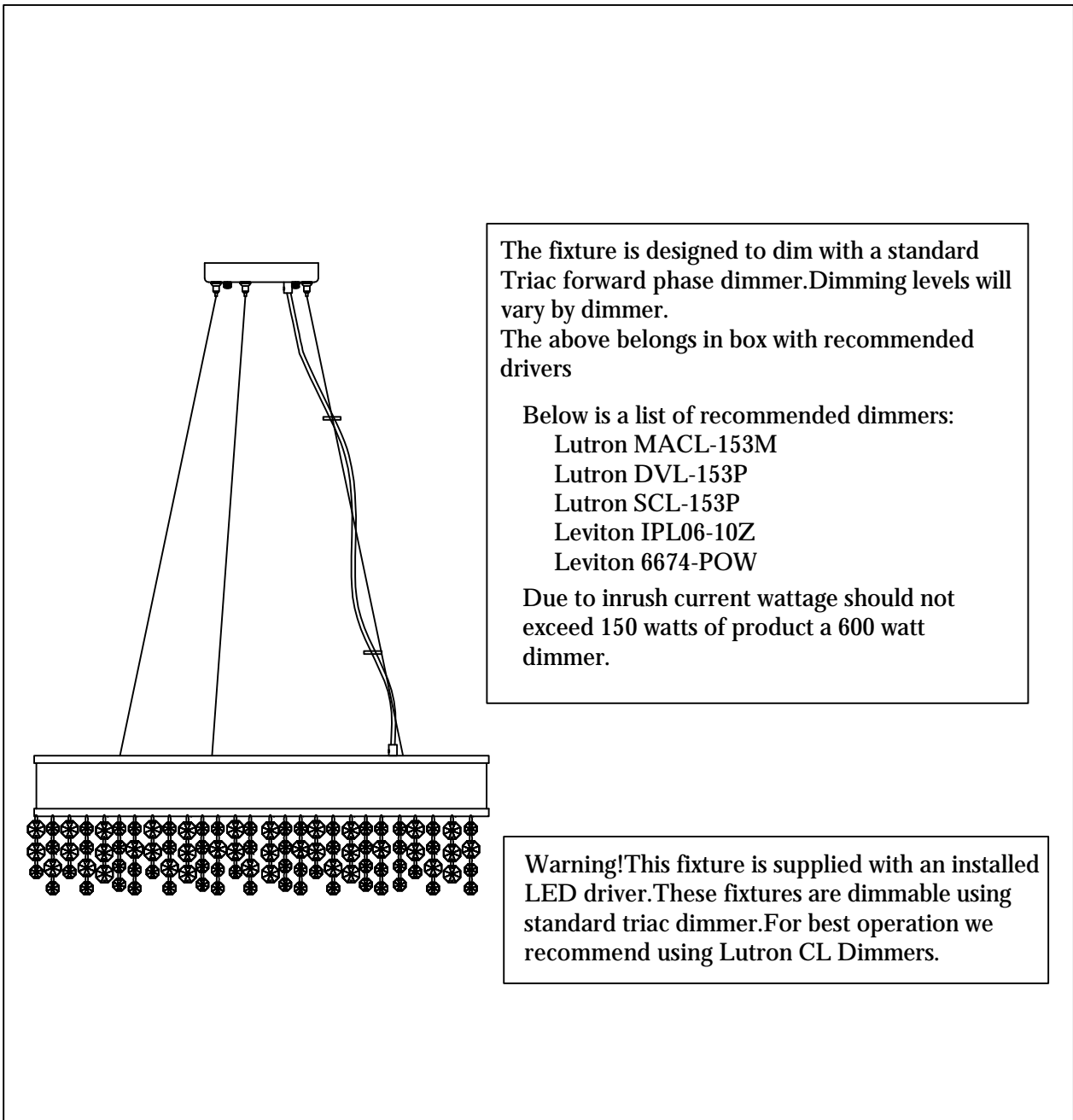

PRODUCT NAME: Mystic
ITEM NUMBER: 39655SHBZ

Please consult your electrician for hanging fixture and wiring.



The fixture is designed to dim with a standard Triac forward phase dimmer. Dimming levels will vary by dimmer. The above belongs in box with recommended drivers

Below is a list of recommended dimmers:

Lutron MACL-153M

Lutron DVL-153P

Lutron SCL-153P

Leviton IPL06-10Z

Leviton 6674-POW

Due to inrush current wattage should not exceed 150 watts of product a 600 watt dimmer.

Warning! This fixture is supplied with an installed LED driver. These fixtures are dimmable using standard triac dimmer. For best operation we recommend using Lutron CL Dimmers.

16*2.8W LED

IMPORTANT: Turn off the power at the main fuse or circuit breaker box before starting installation



(A)
Mounting Bracket



(B)
Anchor Bolts

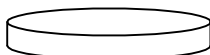

(C)
Canopy



(D)
Finial



(F)
Crystal

Locate all hardware & components before discarding packaging

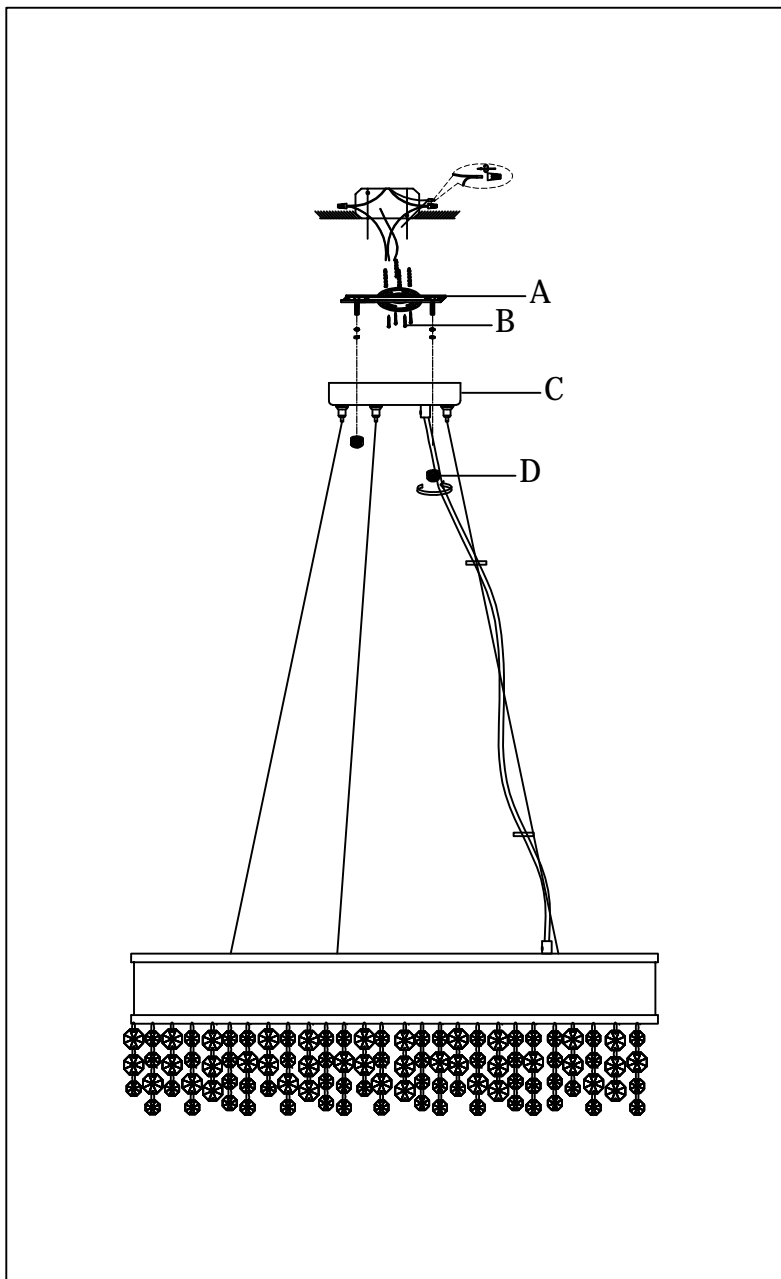

Cleaning & Care:
Clean with soft cloth and a mild detergent.
Do not use abrasive cleaner.

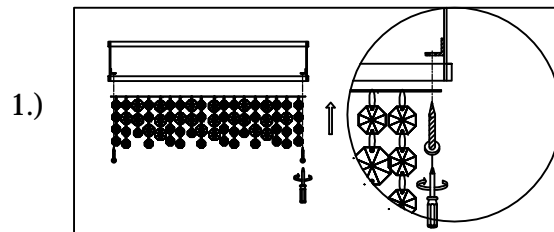

1.) Step.1: Secure the crystal strand assembly (F) to the lamp body using provided screws.

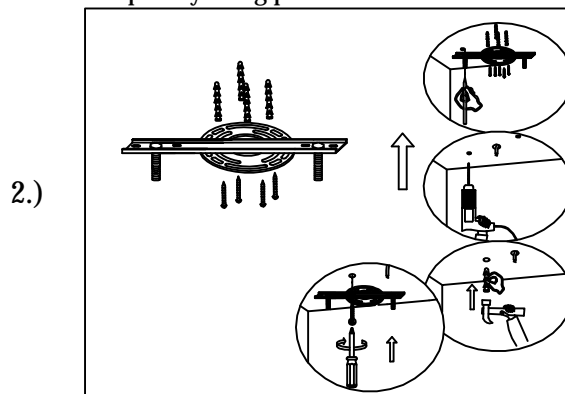

2.) Step.2: Remove mounting bracket (A) and install to electrical box. Mark where anchors meet ceiling, remove mounting bracket from ceiling, and then drill holes using $\frac{3}{16}$ " drill bit where marked (B). Install mounting bracket and attach anchors to secure bracket at ends.

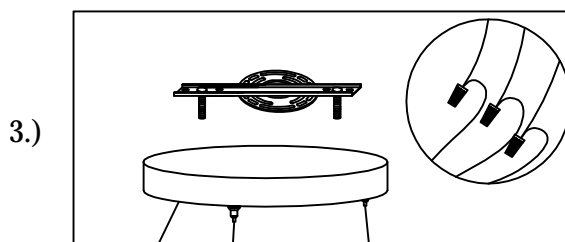

3.) Step.3: Wire fixture to wires in outlet box. Green wire is for Ground.

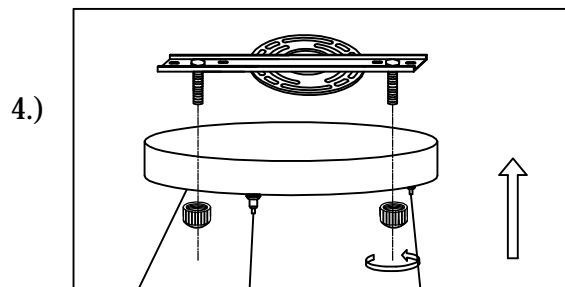

4.) Step.4: Screw finials (D) onto mounting bracket (A) until canopy is flush with ceiling. Adjust wire to desired mounting height.