

Meter Mounting Equipment

Central Hudson Service Area
New York State Electric & Gas Service Area
National Grid NY Service Area
Rochester Gas & Electric Service Area



MILBANK®





Charles A. Milbank
1879-1966



Bill Martin
1916-1998



Robert F. Waldrop
1922-2002



Robert F. Waldrop, II
Chairman



Katrina Waldrop Henke
Vice Chairman

Milbank: Quality Metering Products for 80+ Years

Milbank Manufacturing Company was established in 1927 by Charles A. Milbank. Originally, the company manufactured high voltage switches; however, by 1941 Milbank devoted itself primarily to the manufacture of sheet metal enclosures and related equipment for the electrical generation and distribution industry. Today we are an industry leader in the manufacture of electrical meter sockets. Through a national network of manufacturer's representatives we provide wholesale electrical distributors with quality electrical products for the utility, contractor, industrial and OEM markets.

As the meter standards have changed, Milbank has been successful in adapting its product line to these changes. Our full scale engineering department designs products to meet customer specifications and satisfy all utility requirements. Milbank's employee base of over 1,000 workers, along with our

five manufacturing facilities comprising almost 550,000 square feet give us the flexibility to schedule, produce, and ship orders quickly. Currently, Milbank manufactures over 10,000 different catalog items, and this list continues to grow. Our unique product offering includes: Residential & Commercial Meter Sockets; Residential & Commercial Meter Pedestals; RV/MH Power Outlets, Service Pedestals, and Transformers; Commercial & Industrial Electrical Enclosures; Circuit Breakers; Disconnects & Safety Switches; Safety Sockets; Utility & Residential Secondary Pedestals; Hubs, and related accessories. If you don't find a unit in this catalog to service your needs, send us your specifications and we will be happy to work with you.

Our success has come from a loyal customer base that can rely on us to build quality products at a fair price in a timely manner. Our willingness and ability to design and produce new products

to meet our customer demands is an important factor to remain competitive in today's electrical market.

Milbank has been serving the electric utility & wholesale distribution industries for more than 80 years with innovative, quality engineered products. So remember us for all of your meter mounting and related requirements, and we will be happy to serve you as we have in the past—with dependable service and quality products!

We take great pride in being one of the few family-owned businesses left in our industry. We are a third generation run business and truly believe that...

**FAMILY MAKES A
DIFFERENCE!**



Catalog Number Logic	4	
DISCONNECTS		
U3802, U3832, U386030 & 60 Amp, Fusible / Non-Fusible AC Disconnect	5
U3822-20GWR60 Amp Non-Fused AC Disconnect / 20 Amp GFCI Receptacle	6
U4881-O	Spa Box with Breaker Provision & GFCI Protection	6
U4881-O-50GB, U4881-O-60GB50 & 60 Amp Spa Boxes with GFCI Protection	6
COMMERCIAL METER PEDESTALS		
Overview	7	
Applications & Accessories	8	
SINGLE POSITION		
U4175-RL-BLG100 Amp, 4 Terminal, Load Control Socket	9
U7487-RL-TG-KK125 Amp, 4 Terminal, OH/UG, Horn Bypass	10
U7040-RL-TG-KK-RGE200 Amp, 4 Terminal, OH/UG, Horn Bypass	10
U7021-RL-TG-KK-RGE200 Amp, 4 Terminal, OH, Horn Bypass	10
U9090-O200 Amp, 4 Terminal, UG	11
U5168/5268 Series100-200 Amp, 4 Terminal Meter Main, OH/UG, Horn Bypass	12
SINGLE POSITION HEAVY DUTY LEVER BYPASS		
U9801-R200 Amp, 4 Terminal, 1Ø3W, OH/UG	13
U9551-RXL200 Amp, 5 Terminal, 1Ø3W or 3Ø3W, OH/UG	13
U9551-RL200 Amp, 5 Terminal, 1Ø3W or 3Ø3W, OH/UG	13
U2048-RL200 Amp, 5 Terminal, OH	13, 14
U2047-O200 Amp, 5 Terminal, UG	14
U2049-RL200 Amp, 7 Terminal, OH	14
U2046-O200 Amp, 7 Terminal, UG	14
U9701-R200 Amp, 7 Terminal, OH/UG, 3Ø4W	14
U2448-X-RGE320 Amp, 4 Terminal, OH/UG, Side Wireway	15
U5161-X320 Amp, 4 Terminal, OH/UG, Side Wireway	15
U2594-X320 Amp, 7 Terminal, OH/UG, 3Ø4W, Side Wireway	15
U4013-X320 Amp, 7 Terminal, OH/UG, 3Ø4W, Side Wireway	15
CONDOMINIUM METER BANKS		
U2852-U2856125 Amp/Position, 4 Terminal, 200 & 400 Amp Main Bus Ratings	16
U2862-U2866200 Amp/Position, 4 Terminal, 250, 300, 400 & 600 Amp Main Bus Ratings	16
MULTIPLE POSITION (HORIZONTAL GANGS)		
U1252-R-KK-RGE2 Position, 200 Amp / Pos., 4 Terminal, 1Ø3W, OH/UG, Horn Bypass	17
U1253-R-KK-RGE3 Position, 200 Amp / Pos., 4 Terminal, 1Ø3W, OH/UG, Horn Bypass	17
U1254-R-KK-EX-RGE4 Position, 200 Amp / Pos., 4 Terminal, 1Ø3W, OH/UG, Horn Bypass	17
U1255-R-KK-EX-RGE5 Position, 200 Amp / Pos., 4 Terminal, 1Ø3W, OH/UG, Horn Bypass	17
U1256-R-KK-EX-RGE6 Position, 200 Amp / Pos., 4 Terminal, 1Ø3W, OH/UG, Horn Bypass	17
U2872-XT2 Position, 200 Amp / Pos., 5 Terminal, 1Ø3W, OH/UG HD Lever Bypass	18
U2873-XT3 Position, 200 Amp / Pos., 5 Terminal, 1Ø3W, OH/UG HD Lever Bypass	18
U2874-XT4 Position, 200 Amp / Pos., 5 Terminal, 1Ø3W, OH/UG HD Lever Bypass	18
U2875-XT5 Position, 200 Amp / Pos., 5 Terminal, 1Ø3W, OH/UG HD Lever Bypass	18
U2876-XT6 Position, 200 Amp / Pos., 5 Terminal, 1Ø3W, OH/UG HD Lever Bypass	18
U2732-XT2 Position, 200 Amp / Pos., 7 Terminal, 3Ø4W, OH/UG HD Lever Bypass	18
U2733-XT3 Position, 200 Amp / Pos., 7 Terminal, 3Ø4W, OH/UG HD Lever Bypass	18
U2734-XT4 Position, 200 Amp / Pos., 7 Terminal, 3Ø4W, OH/UG HD Lever Bypass	18
U2735-XT5 Position, 200 Amp / Pos., 7 Terminal, 3Ø4W, OH/UG HD Lever Bypass	18
U2736-XT6 Position, 200 Amp / Pos., 7 Terminal, 3Ø4W, OH/UG HD Lever Bypass	18
MOBILE HOME		
U4093N-O1 Position Pedestal, 200 Amp / Pos., 4 Terminal, Circuit Breaker Provisions	19
U5136 Series & Accessories1 Position Pedestal, 100 & 200 Amp, 4 Terminal, Circuit Breaker Provisions	20, 21
CT ENCLOSURES AND SOCKETS		
U4493-XL80 Amp, 13 Terminal CT Rated Socket, OH/UG, Lever Bypass	22
S1855-OCurrent Transformer Enclosure – 400-800 Amp	23
S1856-OCurrent Transformer Enclosure – 800-1200 Amp	23
CT3R Series & PanelsCurrent Transformer Enclosures & P Series Steel Back Panels	24
363610-TC3R-H-BP-SPCurrent Transformer Enclosure – National Grid Approved	25
ACCESSORIES	26, 27	
MISCELLANEOUS		
Conduit & Ampacity Information	28	
Energization of Electrical Equipment	29	
Materials and Finishes	30	
Meter Forms	31	
Index / Utility Approval Matrix	32	
Other Milbank Products	33	
Commercial Pedestal Worksheet	34	

Catalog Number Logic

U = UL Listed
S = Non-UL Listed
UAP = UL / Alum / Painted

Milbank Drawing Number

TG = Triplex Ground
QG = Quadplex Ground

KK = Horn By-Pass Provision

Specific Utility Designation

Barrel Lock

U7040-RL-TG-KK-5T9-BL-AUT

HUB OPENINGS / CLOSING PLATES

O	Plain Top	WL	1"	For -RL Opening
RL	Small Hub Opening	YL	1¼"	For -RL Opening
R	Large Hub Opening	ZL	1½"	For -RL Opening
XL	Small Closing Plate	DL	2"	For -RL Opening
X	Large Closing Plate	EL	2½"	For -RL Opening
RXL	Large Hub Opening adapted to small Closing Plate.	F	3"	For -R Opening
		G	3½"	For -R Opening
RRL	Large Hub Opening adapted to small Hub Opening	H	4"	For -R Opening

Fifth Terminal Designation

- 5T6 installed at 6:00
- 5T9 installed at 9:00

Barrel Lock / Guard Provision

U2448-X-QG-5T9-K3-BLG-ARE

Milbank Drawing Number

TG = Triplex Ground
QG = Quadplex Ground

Specific Utility Designation

Lugs [1Ø or 3Ø – 350 or 600 kcmil]

- Single [K1, K3, K5, K7]
- Twin [K2, K4, K6, K8]



U3802



U3832

PROFILE

Milbank's air conditioner disconnect has a removable hinged cover which makes wiring a breeze. Our compact design meets all wire bending space requirements in the NEC and, also, complies with article 440-14 in the NEC. To insure the safest conditions, we designed our disconnect pullers to be removable or they may be reinstalled in the off position. Another safety feature is the padlock provision on the front cover. As with all Milbank products, our enclosure is constructed of G90U galvanized steel and finished with an attractive, light gray, baked powder coating. Our state of the art finish combines epoxy and polyester hybrid resins into a hybrid powder coating which is then electrostatically applied. This offers a durable, nonfading finish.

TECHNICAL INFORMATION

AMP	TYPE	CATALOG NUMBER	MAX H.P.	WT. @ #	LINE & LOAD WIRE RANGE		GROUND WIRE RANGE	DIMENSIONS			WIRE RATING	
					CU	AL	CU/AL	D"	W"	H"	CU °C	AL °C
60	NON FUSIBLE	U3802	10	3.25	#14-#2 AWG	#12-#2 AWG	#14-4 AWG	2-1/2	5	7-1/2	60°/75°	60°/75°
30	FUSIBLE	U3832	3	2.5	#14-#3 AWG	#14-#3 AWG	#14-3 AWG	2-1/8	5	7	60°/75°	60°
60	FUSIBLE	U3860	10	3.3	#14-#3 AWG	#14-#3 AWG	#14-3 AWG	3	5	9-1/4	60°/75°	60°/75°

- ✓ UL Listed as Enclosed Pullout Switch
 - ✓ 1Ø, 240 VAC
 - ✓ Type 3R Rainproof
- ✓ One-inch concentric knockouts

Utility requirements for this equipment may vary. Always consult the serving utility for their requirements before ordering or installing equipment in this catalog.

Combination AC Disconnect / 20 Amp GFCI Receptacle—Together in 1 Box

AC DISCONNECT / SPA BOX

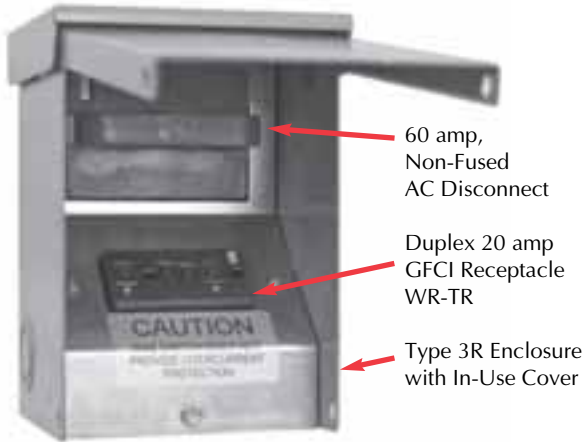

U3822-20GWR

- Meets NEC #210.63 Requirements*
- UL Listed as Power Outlet
- Type 3R Enclosure
- In-Use Cover**
- Duplex Ground Connector
- 1" Concentric Knockouts

AC DISCONNECT

- 1Ø, 240 Volt
- 60 amp, Non-Fused

GFCI RECEPTACLE

- 20 amp
- Reset/Test Button
- Weather Resistant/Tamper Resistant
- Meets NEC #406.8 Requirements*

* NEC® #210.63 Heating, Air-Conditioning and Refrigeration Equipment Outlet.
 ...The receptacle shall be located on the same level and within 7.5 m (25 ft.) of the heating, air-conditioning and refrigeration equipment.

* NEC® #210.68 Ground-Fault Circuit – Interruptor protection for personnel.

* NEC® #406.8 receptacles in damp or wet locations.

AMP	TYPE	CATALOG NUMBER	MAX H.P.	WT. @ #	LINE & LOAD CONNECTOR WIRE RANGE		GROUND CONNECTOR WIRE RANGE	DIMENSIONS			WIRE RATING	
					CU	AL	CU/AL	D"	W"	H"	CU °C	AL °C
60	NONFUSIBLE	U3822-20GWR	10	6	#14-#2 AWG	#12-#2 AWG	#14-4 AWG	4.8	5.25	7.4	60°/75°	60°/75°

To ensure the safest conditions, Milbank disconnect pullers are designed to be reversible so they may be reinstalled in the OFF position. All units are designed with a padlock provision on the cover for security.

****Note: U3822-20GWR** cover rated as *IN-USE COVER* (Cover may be closed with cords plugged into receptacle). Units supplied with WRTR receptacle.

*Reprinted with permission from NFPA 70-2002, *National Electrical Code*®, Copyright 2001, National Fire Protection Association, Quincy, MA 02269. This reprinted material is not the complete and official position of the NFPA on the referenced subject, which is represented only by the standard in its entirety. National Electrical Code® and NEC® are registered trademarks of the National Fire Protection Association, Quincy, MA.

Hot Tub Disconnect or Sub Panel Breaker Enclosure—Type 3R

Spa Box with GFCI Protection



U4881-O-50GB

- 240 Volt ground fault protection
- UL listed, Type 3R rainproof
- Milbank reliability
- Easy installation
- 2 pole, 50 amp GFCI breaker protection
- Compact size:
8-1/2" H x 7-1/2" W x 3-3/4" D
- 3 or 4 wire installation
- 1Ø, 120 / 240 VAC
- Standard package of 12
- 2 extra one-pole breaker spaces
- 100 amp overall rating

Sub Panel Breaker Enclosure

- Use as a 100 amp, 4 circuit sub pane enclosure
- U4881-O has provision for (2) 2-pole or (4) 1-pole small frame breakers



AMP	TYPE	CATALOG NUMBER	WT. @ #	LINE & LOAD CONNECTOR WIRE RANGE		GROUND CONNECTOR WIRE RANGE	DIMENSIONS		
				CU	AL	CU/AL	D"	W"	H"
—	BREAKER PROVISION	U4881-O	7	#14-1/0	#14-1/0	#14-1/0	3 3/4	7 1/2	8 1/2
50	BREAKER	U4881-O-50GB	8	#14-1/0	#14-1/0	#14-1/0	3 3/4	7 1/2	8 1/2
60	BREAKER	U4881-O-60GB	8	#14-1/0	#14-1/0	#14-1/0	3 3/4	7 1/2	8 1/2



Commercial Pedestals

- *Attractive*
- *Easy to install*
- *Secure*
- *Cost effective*

**Un-Strut
Your
Stuff...**

Milbank Commercial Pedestals are pad-mounted, weatherproof electrical enclosures consisting of a utility pull section with optional meter socket, and a customer section containing distribution and control equipment. Milbank Commercial Pedestals are an attractive, secure, easy to install and cost-effective solution when underground remote site power distribution and control equipment is required, replacing unsightly and inefficient strut and backboard structures.



Strut and backboard design



Commercial Pedestal

UL Listed as Industrial Control Equipment (File E113855).

STANDARD FEATURES –COMMERCIAL PEDESTALS

- Type 3R rainproof, vandal-resistant cabinet of polyurethane powder-coated steel (aluminum or stainless steel also available)
- UL listed as enclosed industrial control equipment (UL508)
- Isolated, lockable & sealable utility metering & lug landing sections
- Lockable customer section for distribution & control equipment with internal deadfront
- Print pocket inside customer section door contains wiring schematics and installation instructions
- Most load centers are UL listed for use with various manufacturers' circuit breakers
- All stainless steel external hardware (screws, bolts, hinges, handles, hasps and sealing screws)
- Meets EUSERC 308 and other utility standards.



Ringless Socket



Ring-type Socket



Utility Lug Landing



Customer Interior



Utility requirements for this equipment may vary. Always consult the serving utility for their requirements before ordering or installing equipment in this catalog.

APPLICATIONS

These units are ideal for controlling and metering:

- Traffic signals
- Street lighting
- Irrigation / sprinkler systems
- Cell towers / telephone vaults
- Pump stations
- Temporary power for fairgrounds, swap meets, outdoor markets, portable offices, holiday lights, etc.
- Outdoor lighting for athletic fields, tennis and basketball courts, parking lots, landscaping and subdivision entrances, etc.



AVAILABLE FACTORY-INSTALLED OPTIONS

- Meter sockets – ring type or **ringless**, to 400 amp (unmetered pedestals also available)
- Main and branch breakers or T fuses
- Distribution – copper load centers & panel boards
- Clocks / timers / relays
- Photoelectric cells and controls
- Power receptacles – pin & sleeve, twist lock or straight blade
- Contactors – definite purpose, electrical or mechanically held, IEC and mercury types
- Surge protection & lightning arrestors
- Reserve inlet generator receptacle with interlocked circuit breakers
- Motor starters, relays
- Push button controls
- Thermostat controls, fans and heating strips
- Power blocks and terminal blocks
- Steel, aluminum and plywood back boards
- Transformers
- Interlock devices for circuit breakers
- Available in steel, aluminum (raw painted or anodized) or stainless steel construction with powder-coated finish available in 8 standard colors or special ordered RAL colors.
- Available for applications up to 400 amp, 120V, 208V, 240V, 277V, 480V – 1Ø or 3Ø.

ACCESSORIES



K3865

Fifth terminal kit for use with ringless meter sockets

105J

Fifth terminal kit for use with ring-type meter sockets



CP-TC7D 7-day time clock kit

CP-TC24H 24-hour time clock kit

CP-TCWIRE Male four-pin connector and wiring harness for use with time clocks other than shown



CP-ABK5/8

Anchor bolt kit (includes four 5/8 - 13 x 18" anchor bolts)

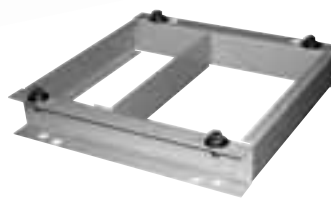

CP-16PDMNT-CALT

Pedestal mounting base for 16" pedestal

CP-24PDMNT-CALT

Pedestal mounting base for 24" pedestal (includes mounting hardware)



CP-PE-HOA-3POS

HOA switch – for field installation

Use the Commercial Pedestal Worksheet found on Page 33 to request a quote.

Utility requirements for this equipment may vary. Always consult the serving utility for their requirements before ordering or installing equipment in this catalog.

SEE INDEX ON PAGE 32 FOR UTILITY APPROVALS

NATIONAL GRID NY SERVICE AREA APPROVED

100 AMP-4 TERMINAL-LOAD CONTROL SOCKET-600 VAC

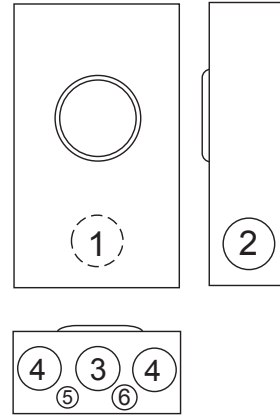

U4175-RL-BLG

100 AMP-4 TERMINAL-LOAD CONTROL SOCKET-RINGLESS*

CATALOG NUMBER	UTILITY NUMBER	HUB	CONNECTORS CU/AL	BY-PASS	DIMENSIONS			CONCENTRIC K.O.'S					
					D"	W"	H"	1	2	3	4	5	6
U4175-RL-BLG	M-361	H.O.	#12-#1 AWG	NONE	3 ⁵ / ₁₆	8	11 ¹ / ₂	1 ¹ / ₂	1 ¹ / ₂	2	1 ¹ / ₄	—	1 ¹ / ₄

HUB: For proper hub selection, see the hub suffix chart on the accessory page.

***APPLICATION:** For use on CATV Power Supply Service, Billboard Lighting Service, Traffic Signal Service.

Utility requirements for this equipment may vary. Always consult the serving utility for their requirements before ordering or installing equipment in this catalog.



125 / 200 AMP-4 TERMINAL-600V

SEE INDEX ON PAGE 32 FOR UTILITY APPROVALS



U7487-RL-TG-KK
(APPROVED FOR NYSEG & CENTRAL HUDSON)

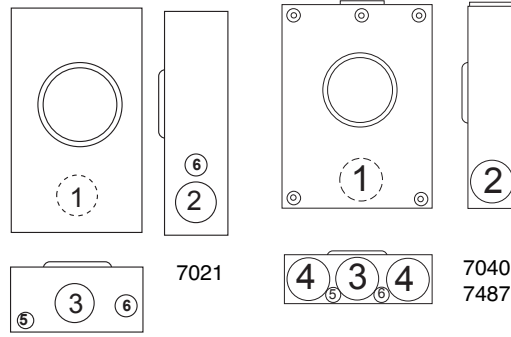

U7040-RL-TG-KK-RGE
(APPROVED FOR NYSEG, RGE & CENTRAL HUDSON)



U7021-RL-TG-KK-RGE
(APPROVED FOR NYSEG, RGE & NATIONAL GRID NY SERVICE AREAS)

125 AMP-4 TERMINAL-RINGLESS

CENTRAL HUDSON CODE #	SVC.	CATALOG NUMBER	HUB	CONNECTORS CU/AL		BY-PASS	DIMENSIONS			CONCENTRIC K.O.'S					
				LINE	LOAD		D"	W"	H"	1	2	3	4	5	6
CH-063	OH/UG	U7487-RL-TG-KK	H.O.	#6-2/0	#6-2/0	HORN	3 ⁵ / ₁₆	8	11 ¹ / ₂	1 ¹ / ₂	1 ¹ / ₂	2	1 ¹ / ₄	—	1 ¹ / ₄

200 AMP-4 TERMINAL-RINGLESS

CENTRAL HUDSON CODE #	SVC.	CATALOG NUMBER	HUB	CONNECTORS CU/AL		BY-PASS	DIMENSIONS			CONCENTRIC K.O.'S					
				LINE	LOAD		D"	W"	H"	1	2	3	4	5	6
CH-069	OH	U7040-RL-TG-KK-RGE *	H.O.	#6-350 kcmil	#6-350 kcmil	HORN	4 ¹ / ₈	11	15 ¹ / ₂	2 ¹ / ₂	2 ¹ / ₂	2 ¹ / ₂	2 ¹ / ₂	1 ¹ / ₄ , 1 ¹ / ₂	1 ¹ / ₄
CH-081	UG									2 ¹ / ₂	2 ¹ / ₂	2 ¹ / ₂	—	1 ¹ / ₄	1 ¹ / ₄ , 1 ¹ / ₂
—	OH	U7021-RL-TG-KK-RGE	H.O.	#6-350 kcmil	#6-350 kcmil	HORN	4 ¹ / ₈	8	15 ¹ / ₂	2 ¹ / ₂	2 ¹ / ₂	2 ¹ / ₂	—	1 ¹ / ₄	1 ¹ / ₄ , 1 ¹ / ₂

FIFTH TERMINAL: For field mounted fifth terminal order catalog number **5T8K2** for 100 amp unit. For 200 amp units, order **K5T**.

CONNECTORS: Extruded aluminum connectors are tin plated. Units are supplied with duplex neutral.

BYPASS: Horn type bypass is provided.

***UNDERGROUND SERVICE:** A closing plate must be used when the **U7040-RL-TG-KK-RGE** is designated for underground service. Order closing plate catalog number **A7551** as extra.



Utility requirements for this equipment may vary. Always consult the serving utility for their requirements before ordering or installing equipment in this catalog.

SEE INDEX ON PAGE 32 FOR UTILITY APPROVALS

NATIONAL GRID NY SERVICE AREA APPROVED

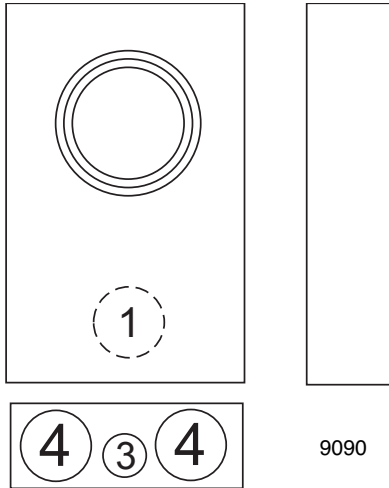

U9090-O

200 AMP-4 TERMINAL-RINGLESS

SERVICE	CATALOG NUMBER	UTILITY NUMBER	HUB	CONNECTORS CU/AL		BY-PASS	DIMENSIONS			CONCENTRIC K.O.'S				
				LINE	LOAD		D"	W"	H"	1	2	3	4	5
UG	U9090-O	M-301	BLANK	3/8"-16 STUD	#6-350 kcmil	NONE	4 ¹ / ₂	9	20 ³ / ₄	2 ¹ / ₂	—	1/4, 1/2	2 ¹ / ₂	—

FIFTH TERMINAL: For the field mounted fifth terminal, order as extra catalog number **K5T**.

***CONNECTORS:** Line and neutral service is supplied with 3/8"-16 studs with hex head nuts and captive Belleville washers. One hole compression lugs per National Grid NY standards are to be supplied by the contractor. Loadside is supplied with 350 kcmil, lay-in type connectors.

Utility requirements for this equipment may vary. Always consult the serving utility for their requirements before ordering or installing equipment in this catalog.



SEE INDEX ON PAGE 32 FOR UTILITY APPROVALS



U5168-XTL-200

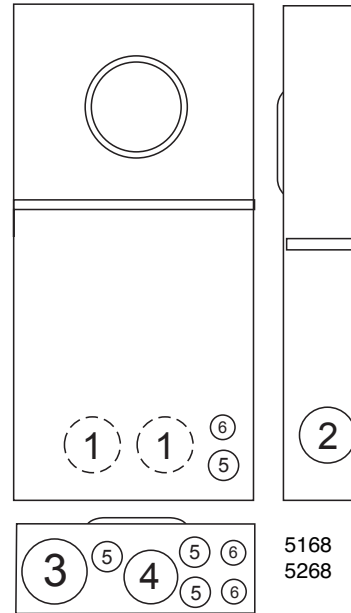

5168
5268

100, 150 & 200 AMP-4 TERMINAL-METER MAIN-OVERHEAD/UNDERGROUND-22K AIC-1Ø3W

AMPS	NO. OF CIRCUITS	CATALOG NUMBER	HUB	CONNECTORS LINE	BY-PASS	DIMENSIONS			CONCENTRIC K.O.'S					
						D"	W"	H"	1	2	3	4	5	6
100	8	U5168-XTL-100-KK	C.P.	#6-350 kcmil	HORN	4 1/2	14 1/8	32	2	2	3	2 1/2	1 1/2, 3/4, 1	1 1/2, 3/4
150	8	U5168-XTL-150-KK	C.P.	#6-350 kcmil	HORN	4 1/2	14 1/8	32	2	2	3	2 1/2	1 1/2, 3/4, 1	1 1/2, 3/4
200	8	U5168-XTL-200-KK	C.P.	#6-350 kcmil	HORN	4 1/2	14 1/8	32	2	2	3	2 1/2	1 1/2, 3/4, 1	1 1/2, 3/4
150	20	U5268-XTL-150-KK	C.P.	#6-350 kcmil	HORN	4 1/2	14 1/8	32	2	2	3	2 1/2	1 1/2, 3/4, 1	1 1/2, 3/4
200	20	U5268-XTL-200-KK	C.P.	#6-350 kcmil	HORN	4 1/2	14 1/8	32	2	2	3	2 1/2	1 1/2, 3/4, 1	1 1/2, 3/4
100	8	U5168-XTL-100-KK-PL**	C.P.	#6-350 kcmil	HORN	4 1/2	14 1/8	32	2	2	3	2 1/2	1 1/2, 3/4, 1	1 1/2, 3/4
200	8	U5168-XTL-200-KK-PL**	C.P.	#6-350 kcmil	HORN	4 1/2	14 1/8	32	2	2	3	2 1/2	1 1/2, 3/4, 1	1 1/2, 3/4

HUB: Supplied with (2) closing plates packed inside. Order hubs as a separate item. See accessory page for hub options.

INTERIOR: U5168 units have 8 circuit interior; U5268 units have 20 circuit interior.

FIFTH TERMINAL: Order K5T and field install in the 9 o'clock position only.

BREAKERS: Rated 22K AIC with QNR2200H main installed.

INTERLOCK KIT: For generator auxiliary circuit breaker interlock, order K5815 for large QN with small frame Q; order K5820 for large frame QN with large frame QN.

***SUB-FEED LUGS:** #6-350 kcmil sub-feed lugs provided on 8 circuit interior. Not available on 20 circuit interior.

****National Grid NY Service Area –** for overhead and underground when underground service is a complete cable-in-conduit system.

PLUG-IN BREAKER COMPATIBILITY CHART

AMPS	CUTLER-HAMMER (WESTINGHOUSE)	SIEMENS (ITE)	SIEMENS MURRAY / CROUSE-HINDS	G.E.	SQ-D
125-200	HQP / BR / WBJ	QN	MD	THQ	—
≤ 100	QP / BR / HQP	QP	MP	THQ	HOMELINE

MAIN CIRCUIT BREAKER CHART

Amperage	100	150	200
Catalog No.	Q2100H	QN2150RH	QN2200RH

Utility requirements for this equipment may vary. Always consult the serving utility for their requirements before ordering or installing equipment in this catalog.



SEE INDEX ON PAGE 32 FOR UTILITY APPROVALS

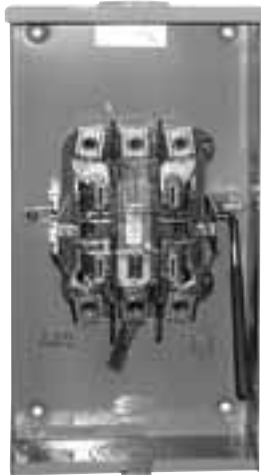

U2048-RL

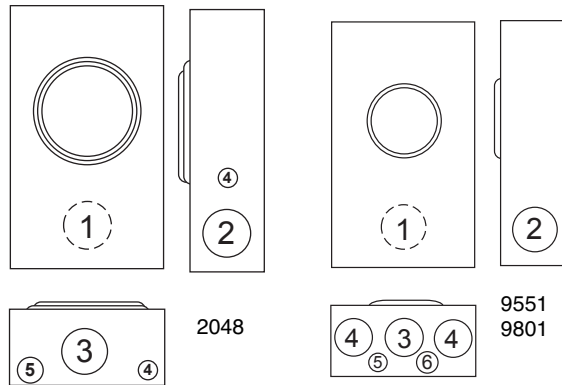

U9551-RXL

200 AMP-4 & 5 TERMINAL-HEAVY DUTY LEVER BYPASS-600 VAC

200 AMP-4 TERMINAL-RINGLESS-1Ø3W-CENTRAL HUDSON APPROVED

CENTRAL HUDSON CODE	SERVICE	CATALOG NUMBER	HUB	CONNECTORS CU/AL		BY-PASS	DIMENSIONS			CONCENTRIC K.O.'S					
				LINE	LOAD		D"	W"	H"	1	2	3	4	5	6
CH-065	OH/UG	U9801-R	H.O.	#6-350 kcmil	#6-350 kcmil	LEVER	4 ⁷ / ₈	13	19	3	2 ¹ / ₂	3	3	1 ¹ / ₄	1 ¹ / ₄ , 1 ¹ / ₂

FIFTH TERMINAL: For field mounted fifth terminal, order as extra **K3866**.

BYPASS: Lever supplies clamping action on meter spades and also operates bypass device.

CONNECTORS: Units are supplied with extruded aluminum connectors, bonded neutral and a grounding stud.

200 AMP-5 TERMINAL-RINGLESS-1Ø3W OR 3Ø3W-CENTRAL HUDSON APPROVED

CENTRAL HUDSON CODE	SERVICE	CATALOG NUMBER	HUB	CONNECTORS CU/AL		BY-PASS	DIMENSIONS			CONCENTRIC K.O.'S					
				LINE	LOAD		D"	W"	H"	1	2	3	4	5	6
CH-116	OH	U2048-RL	H.O.	#6-350 kcmil	#6-350 kcmil	LEVER	4 ⁷ / ₈	10	18 ¹ / ₂	3	2 ¹ / ₂	3	3 ³ / ₄	1 ¹ / ₄ , 1 ¹ / ₂	-
CH-117	OH/UG	U9551-RXL	C.P.	#6-350 kcmil	#6-350 kcmil	LEVER	4 ⁷ / ₈	13	19	3	2 ¹ / ₂	3	3	1 ¹ / ₄	1 ¹ / ₄ , 1 ¹ / ₂

RGE APPROVED

RGE NO.	SERVICE	CATALOG NUMBER	HUB	CONNECTORS CU/AL		BY-PASS	DIMENSIONS			CONCENTRIC K.O.'S					
				LINE	LOAD		D"	W"	H"	1	2	3	4	5	6
R1121	OH/UG	U9551-RL	H.O.	#6-350 kcmil	#6-350 kcmil	LEVER	4 ⁷ / ₈	13	19	3	2 ¹ / ₂	3	3	1 ¹ / ₄	1 ¹ / ₄ , 1 ¹ / ₂

HUBS: For proper hub selection see the hub suffix chart on the accessory page.

BYPASS: Lever supplies clamping action on meter spades and also operates bypass device.

CONNECTORS: Units supplied with extruded aluminum connectors, a bonded neutral and a grounding stud.

FIFTH TERMINAL: Fifth terminal is supplied in the 6 o'clock position. For factory installed fifth terminal in the 9 o'clock position add the suffix **-5T9** to the catalog number. Fifth terminal can be changed in the field from 6 o'clock to 9 o'clock position.

Utility requirements for this equipment may vary. Always consult the serving utility for their requirements before ordering or installing equipment in this catalog.



SEE INDEX ON PAGE 32 FOR UTILITY APPROVALS

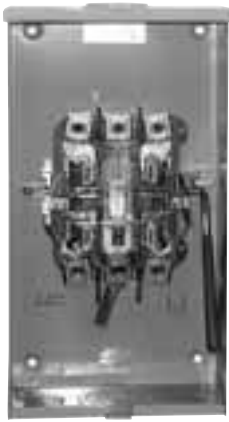

U2048-RL



U2046-O

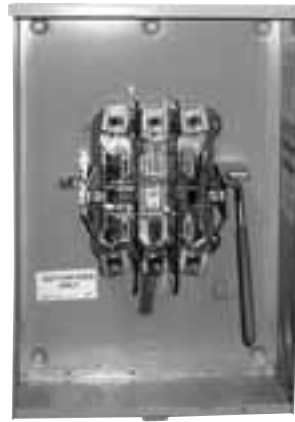

U2047-O



U9701-R

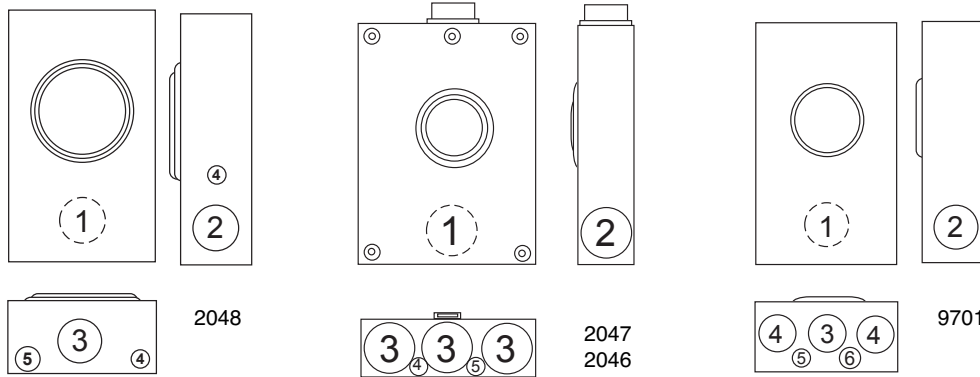

200 AMP-5 & 7 TERMINAL-RINGLESS-LEVER BYPASS

UTILITY	TERMS	CATALOG NUMBER	UTILITY NUMBER	SERVICE	HUB	CONNECTORS CU/AL	BY-PASS	DIMENSIONS			CONCENTRIC K.O.'S				
								D"	W"	H"	1	2	3	4	5
NATIONAL GRID	5	U2048-RL	M-089	OH	H.O.	#6-350 kcmil	LEVER	4 ⁷ / ₈	10	18 ¹ / ₂	3	2 ¹ / ₂	3	3/4	1/4, 1/2
NATIONAL GRID	5	U2047-O	M-090	UG	BLANK	#6-350 kcmil	LEVER	4 ⁷ / ₈	13	19	3	2 ¹ / ₂	3	1/4	1/4, 1/2
NATIONAL GRID	7	U2049-RL	M-101	OH	H.O.	#6-350 kcmil	LEVER	4 ⁷ / ₈	10	18 ¹ / ₂	3	2 ¹ / ₂	3	3/4	1/4, 1/2
NATIONAL GRID	7	U2046-O	M-094	UG	BLANK	#6-350 kcmil	LEVER	4 ⁷ / ₈	13	19	3	2 ¹ / ₂	3	1/4	1/4, 1/2
CENTRAL HUDSON	7	U9701-R	CH-118	OH/UG	H.O.	#6-350 kcmil	LEVER	4 ⁷ / ₈	13	19	3	2 ¹ / ₂	3	1/4	1/4, 1/2

HUB: For proper hub selection, see the hub suffix chart on the accessory page.

LEVER BYPASS: Lever supplies clamping action on meter spades and also operates bypass device.

CONNECTORS: Units supplied with extruded aluminum connectors and bonded triplex ground.

ISOLATED NEUTRAL: For field installed isolated neutral, order kit number K1047.



Utility requirements for this equipment may vary. Always consult the serving utility for their requirements before ordering or installing equipment in this catalog.

SEE INDEX ON PAGE 32 FOR UTILITY APPROVALS



U4013-X

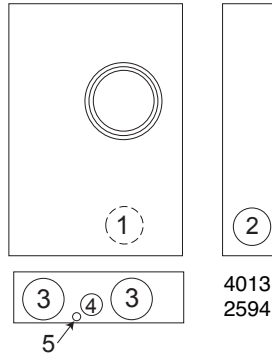

U2448-X-RGE

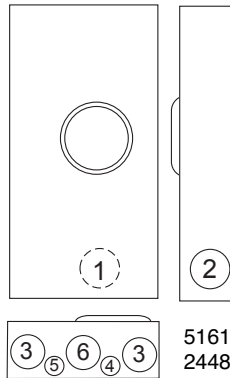

320 AMP-4 TERMINAL-SIDE WIREWAY-RINGLESS-OH/UG

TERMS	CATALOG NUMBER	PHASE	HUB	CONNECTORS	FIFTH TERM. KITS	BY-PASS	DIMENSIONS			CONCENTRIC K.O.'S					
				CU/AL			D"	W"	H"	1	2	3	4	5	6
4	U5161-X	1	C.P.	3/8"-16 STUD	K3865	LEVER	4 ⁷ / ₈	15	31 ¹ / ₂	3	3	3	1/2	1/4	3
4	U2448-X-RGE	1	C.P.	3/8"-16 STUD	K3865	LEVER	6 ¹ / ₂	17 ³ / ₄	34 ¹ / ₈	3	3	4	1	1/4	—

320 AMP-7 TERMINAL-SIDE WIREWAY-RINGLESS-OH/UG

TERMS	CATALOG NUMBER	PHASE	HUB	CONNECTORS	BY-PASS	DIMENSIONS			CONCENTRIC K.O.'S					
				CU/AL		D"	W"	H"	1	2	3	4	5	6
7	U4013-X	3Ø4W	C.P.	3/8"-16 STUD	LEVER	6 ¹ / ₂	17 ³ / ₄	40 ¹ / ₂	4	3	4	1	1/4	—
7	U2594-X	3Ø4W	C.P.	3/8"-16 STUD	LEVER	6 ¹ / ₂	19	34 ¹ / ₈	—	3	4	1	1/4	—

HUBS: For proper hub selection see the hub suffix chart on the accessory page.

BYPASS: The lever supplies clamping action on meter spades and also operates bypass device.

CONNECTORS: Stud type units supplied with 3/8"-16 hex head nuts with Belleville washers. For 1Ø connector kits, order as extra: **K1539** (350 kcmil) or **K1540** (600 kcmil). For twin lug connectors order as extra: **K1350** (350 kcmil). For 3Ø connector kits, order as extra: **K3082** (350 kcmil) or **K3441** (600 kcmil). For twin lug connectors, order as extra: **K3441** (#4-600 kcmil or (2) 1/0-250 kcmil). Separate kits are required for both line and load.

FIFTH TERMINAL: U2448-X-RGE—for factory installed fifth terminal in the 6 o'clock position add the suffix **-5T6** to the catalog number. For factory installed fifth terminal in the 9 o'clock position at the suffix **-5T9** to the catalog number. Catalog number **K3865** is available for field install.

NATIONAL GRID NY PART NOS.: U5161-X, U2448-X-RGE (M-116), U4013-X, U2594-X (M-117). One hole compression lugs per National Grid NY standards to be supplied by contractor.

Utility requirements for this equipment may vary. Always consult the serving utility for their requirements before ordering or installing equipment in this catalog.



SEE INDEX ON PAGE 32 FOR UTILITY APPROVALS

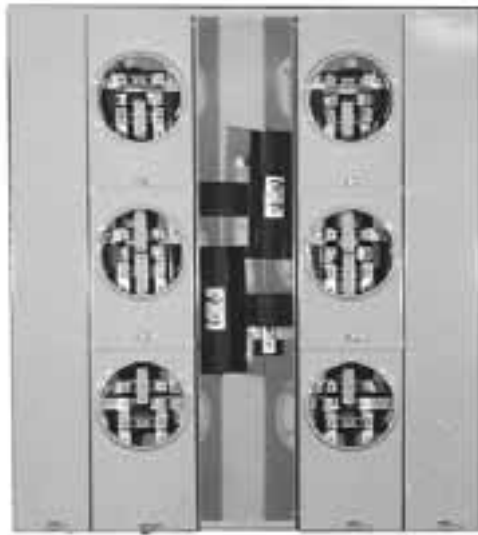

U2866-X

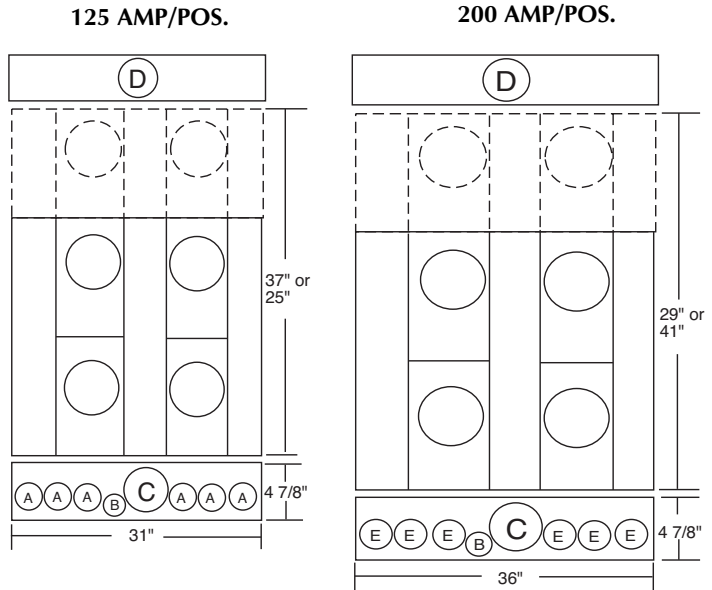

125 AMP/POSITION
(NATIONAL GRID NY SERVICE AREA ONLY)

NO. OF POS.	CATALOG NUMBER	MAIN BUS RATING	LINE CONNECTOR SIZE
2	U2852-X	200 AMP	*3/8"-16 STUD
3	U2853-X	200 AMP	*3/8"-16 STUD
4	U2854-X	400 AMP	*3/8"-16 STUD
5	U2855-X	400 AMP	*3/8"-16 STUD
6	U2856-X	400 AMP	*3/8"-16 STUD

200 AMP/POSITION
(NATIONAL GRID NY SERVICE AREA, RGE APPROVED)

NO. OF POS.	CATALOG NUMBER	MAIN BUS RATING	LINE CONNECTOR SIZE
2	U2862-X	250 AMP	*3/8"-16 STUD
3	U2863-X	300 AMP	*3/8"-16 STUD
4	U2864-X	400 AMP	*3/8"-16 STUD
5	U2865-X	600 AMP	*3/8"-16 STUD
6	U2866-X	600 AMP	*3/8"-16 STUD

FIG.	DIMENSIONS
A	1 1/4" CONCENTRIC K.O.
B	1/4, 1/2" CONCENTRIC K.O.
C	3" CONCENTRIC K.O.
D	4" HUB OPENING
E	2" CONCENTRIC K.O.

PLUG-IN BREAKER COMPATIBILITY CHART

AMPS	CUTLER-HAMMER	SIEMENS	SIEMENS/MURRAY	G.E.	SQ-D
125-200	BR, BJ	QN	MD	Q LINE	—
≤ 100	QUICKLAG P, BR, HQP	QP	MP	Q LINE	HOMELINE

***CONNECTORS:** For line wire connector kits, order separately. See page 26.

FIFTH TERMINALS: For field mounted fifth terminal order catalog number **K2381**. Order one per meter position.

BREAKERS: Units have provision for one double pole main per meter position. Breakers not included. Order as extra.



Utility requirements for this equipment may vary. Always consult the serving utility for their requirements before ordering or installing equipment in this catalog.

SEE INDEX ON PAGE 32 FOR UTILITY APPROVALS

CENTRAL HUDSON, NY STATE ELECTRIC & GAS,
NATIONAL GRID NY SERVICE AREA & RGE APPROVED

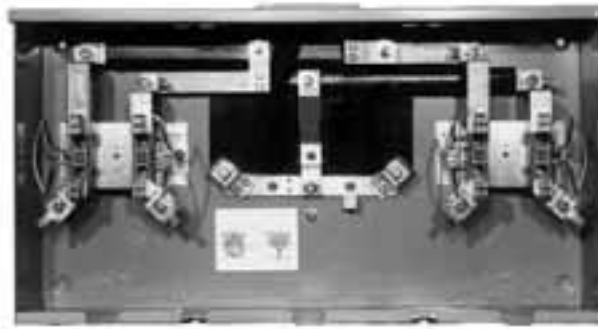

U1252-R-KK-RGE

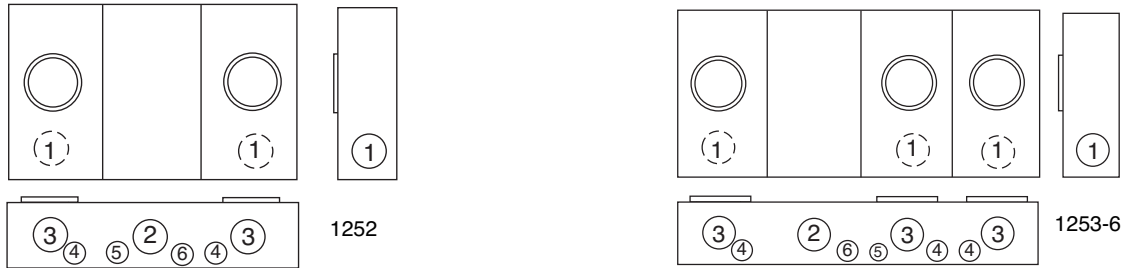

200 AMP / POSITION-4 TERMINAL-RINGLESS-1Ø3W-OH/UG*

AMPS	NO. OF POS.	CATALOG NUMBER	HUB	CONNECTOR CU/AL		BY-PASS	DIMENSIONS			CONCENTRIC K.O.'S					
				LINE	LOAD		D"	W"	H"	1	2	3	4	5	6
200	2	U1252-R-KK-RGE	H.O.	3/8"-16 STUD	#6-350 kcmil	HORN	5 1/8	26 1/2	14	2 1/2	3	2 1/2	1/2	1/4	1
200	3	U1253-R-KK-RGE	H.O.	3/8"-16 STUD	#6-350 kcmil	HORN	5 1/8	34 3/4	14	2 1/2	3	2 1/2	1/2	1/4	1
200	4	U1254-R-KK-EX-RGE	H.O.	3/8"-16 STUD	#6-350 kcmil	HORN	5 1/8	42 7/8	16	2 1/2	3	2 1/2	1/2	1/4	1
200	5	U1255-R-KK-EX-RGE	H.O.	3/8"-16 STUD	#6-350 kcmil	HORN	5 1/8	54 7/8	16	2 1/2	3	2 1/2	1/2	1/4	1
200	6	U1256-R-KK-EX-RGE	H.O.	3/8"-16 STUD	#6-350 kcmil	HORN	5 1/8	63 1/16	18	2 1/2	3	2 1/2	1/2	1/4	1

HUB: For proper hub selection refer to the hub suffix chart on the accessory page. Two hub openings are supplied and the extra opening is closed with a closing plate as standard on the 5 and 6 position units.

FIFTH TERMINAL: For factory installed fifth terminal in the 9 o'clock position, add the suffix **-5T**. For field mounted fifth terminal, order catalog number **K5T** (1 kit per meter position).

CONNECTORS: Extruded aluminum connectors are tin plated. See page 26 for connectors.

BUSSING: Bussing is 5/16" x 1" aluminum on the **U1252-1253**. On the **U1254-6** gangs the bussing is 3/8" x 1" aluminum. Refer to general engineering section of the Standard Catalog for information on ampacity of bussing.

Utility requirements for this equipment may vary. Always consult the serving utility for their requirements before ordering or installing equipment in this catalog.



SEE INDEX ON PAGE 32 FOR UTILITY APPROVALS

NATIONAL GRID NY SERVICE AREA APPROVED



U2732-XT

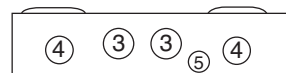
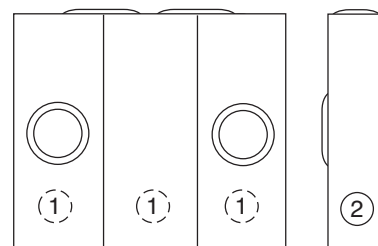

2872-6
2732-6

CENTER WIREWAY

200 AMP -5 TERMINAL-RINGLESS-1Ø3W-OVERHEAD / UNDERGROUND*

AMPS	SERV.	NO. OF POS.	CATALOG NUMBER	HUB	CONNECTOR CU/AL		BY-PASS	DIMENSIONS			CONCENTRIC K.O.'S				
					LINE	LOAD		D"	W"	H"	1	2	3	4	5
200	OH/UG	2	U2872-XT	(2)C.P.	3/8"-16 STUD	#6-350 kcmil	LEVER	6	32 ¹ / ₈	25 ¹ / ₄	2 ¹ / ₂	2 ¹ / ₂	4	2 ¹ / ₂	1 ¹ / ₄ , 1 ¹ / ₂
200	OH/UG	3	U2873-XT	(2)C.P.	3/8"-16 STUD	#6-350 kcmil	LEVER	6	42 ³ / ₁₆	25 ¹ / ₄	2 ¹ / ₂	2 ¹ / ₂	4	2 ¹ / ₂	1 ¹ / ₄ , 1 ¹ / ₂
200	OH/UG	4	U2874-XT	(2)C.P.	3/8"-16 STUD	#6-350 kcmil	LEVER	6	52 ¹ / ₄	25 ¹ / ₄	2 ¹ / ₂	2 ¹ / ₂	4	2 ¹ / ₂	1 ¹ / ₄ , 1 ¹ / ₂
200	OH/UG	5	U2875-XT	(2)C.P.	3/8"-16 STUD	#6-350 kcmil	LEVER	6	62 ⁵ / ₁₆	25 ¹ / ₄	2 ¹ / ₂	2 ¹ / ₂	4	2 ¹ / ₂	1 ¹ / ₄ , 1 ¹ / ₂
200	OH/UG	6	U2876-XT	(2)C.P.	3/8"-16 STUD	#6-350 kcmil	LEVER	6	72 ³ / ₈	31 ¹ / ₄	2 ¹ / ₂	2 ¹ / ₂	4	2 ¹ / ₂	1 ¹ / ₄ , 1 ¹ / ₂

200 AMP -7 TERMINAL-RINGLESS-3Ø4W-OVERHEAD / UNDERGROUND*

AMPS	SERV.	NO. OF POS.	CATALOG NUMBER	HUB	CONNECTOR CU/AL		BY-PASS	DIMENSIONS			CONCENTRIC K.O.'S				
					LINE	LOAD		D"	W"	H"	1	2	3	4	5
200	OH/UG	2	U2732-XT	(2)C.P.	3/8"-16 STUD	#6-350 kcmil	LEVER	6	32 ¹ / ₈	25 ¹ / ₄	2 ¹ / ₂	2 ¹ / ₂	4	2 ¹ / ₂	1 ¹ / ₄ , 1 ¹ / ₂
200	OH/UG	3	U2733-XT	(2)C.P.	3/8"-16 STUD	#6-350 kcmil	LEVER	6	42 ³ / ₁₆	25 ¹ / ₄	2 ¹ / ₂	2 ¹ / ₂	4	2 ¹ / ₂	1 ¹ / ₄ , 1 ¹ / ₂
200	OH/UG	4	U2734-XT	(2)C.P.	3/8"-16 STUD	#6-350 kcmil	LEVER	6	52 ¹ / ₄	25 ¹ / ₄	2 ¹ / ₂	2 ¹ / ₂	4	2 ¹ / ₂	1 ¹ / ₄ , 1 ¹ / ₂
200	OH/UG	5	U2735-XT	(2)C.P.	3/8"-16 STUD	#6-350 kcmil	LEVER	6	62 ⁵ / ₁₆	25 ¹ / ₄	2 ¹ / ₂	2 ¹ / ₂	4	2 ¹ / ₂	1 ¹ / ₄ , 1 ¹ / ₂
200	OH/UG	6	U2736-XT	(2)C.P.	3/8"-16 STUD	#6-350 kcmil	LEVER	6	72 ³ / ₈	31 ¹ / ₄	2 ¹ / ₂	2 ¹ / ₂	4	2 ¹ / ₂	1 ¹ / ₄ , 1 ¹ / ₂

HUBS: Units supplied with two closing plates. To order hubs as extra refer to the hub suffix chart on the accessory page.

BYPASS: Lever supplies clamping action on meter spades and also operates bypass device.

***CONNECTOR KITS:** Line wire sections supplied with studs. For connector kits for the U2872-6 units, order as extra: K1539 (350 kcmil), K1350 (twin 350 kcmil), K1540 (600 kcmil) or K1541 (twin 600 kcmil). For U2732-6 units, order K3082 (350 kcmil), K3442 (twin 350 kcmil), K3441 (600 kcmil) or K3083 (twin 600 kcmil). Line connectors can be reversed to change from "OH" to "UG" service.

BUSSING: Bussing is 3/8" x 1" aluminum. Refer to the conduit & ampacity information page for information on ampacity of bussing.

Utility requirements for this equipment may vary. Always consult the serving utility for their requirements before ordering or installing equipment in this catalog.



200 AMP / POSITION-5 & 7 TERMINAL-HORIZONTAL GANGS-HEAVY DUTY LEVER BYPASS-600 VAC

SEE INDEX ON PAGE 32 FOR UTILITY APPROVALS

200 AMP–MOBILE HOME METER PEDESTALS–4 TERMINAL–120 / 240 VAC

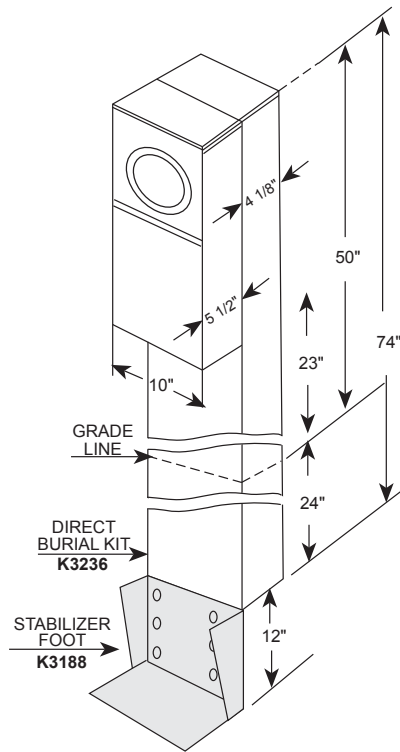

U4093N-O

**MAIN BREAKERS
(SERIES WIRED)**

CATALOG NUMBER	AMPS
UQFP-M-100	100
UQFP-M-125	125
UQFP-M-150	150
UQFP-M-200	200

BRANCH BREAKERS

AMPS	MILBANK	CUTTLER-HAMMER / WESTINGHOUSE	SIEMENS / ITE	MURRAY / CROUSE-HINDS	G.E.	SQ-D
125 OR LESS	Q	QUICKLAG P BR / HQP	QP	MP-T	THQ	HOME LINE

200 AMP–4 TERMINAL–RINGLESS

CATALOG NUMBER	METER POSITIONS	MOUNTING TYPE	LINE CONNECTOR CU/AL	CIRCUIT PROV.	LBS.	DESCRIPTION
U4093N-O	SINGLE	POST	3/8" - 16 STUD	6	100#	Provisions for Main with Branch or Parallel Breakers

APPLICATION: Pedestals are suitable for use as mobile home service equipment. These units are in stock, wired as parallel, without breaker. They have provisions for one double, and two single circuit branch breakers in addition to the main. Order breakers separately (see chart above.) Quadplex style breakers may be used in accordance to the NEC. For main style breakers (series wired), order **UQFP-M**, plus kit **K4714** (includes wire assemblies, hardware, instructions and label).

REQUIRED ACCESSORIES: Pedestal must be used with Direct Burial Kit **K3236 / K3188** (22 lbs.) which is furnished as part of unit and is included in price. Pad Mount Sleeve **K3237** (6 lbs.) can be ordered as an extra option, and is required if unit is to be pad-mounted.

22K AIC—CONSULT FACTORY

FIFTH TERMINAL: For field installed fifth terminal, use **K5T** in the 9 o'clock position.

Utility requirements for this equipment may vary. Always consult the serving utility for their requirements before ordering or installing equipment in this catalog.



SEE INDEX ON PAGE 32 FOR UTILITY APPROVALS



U5136-O-200S
with series wired main

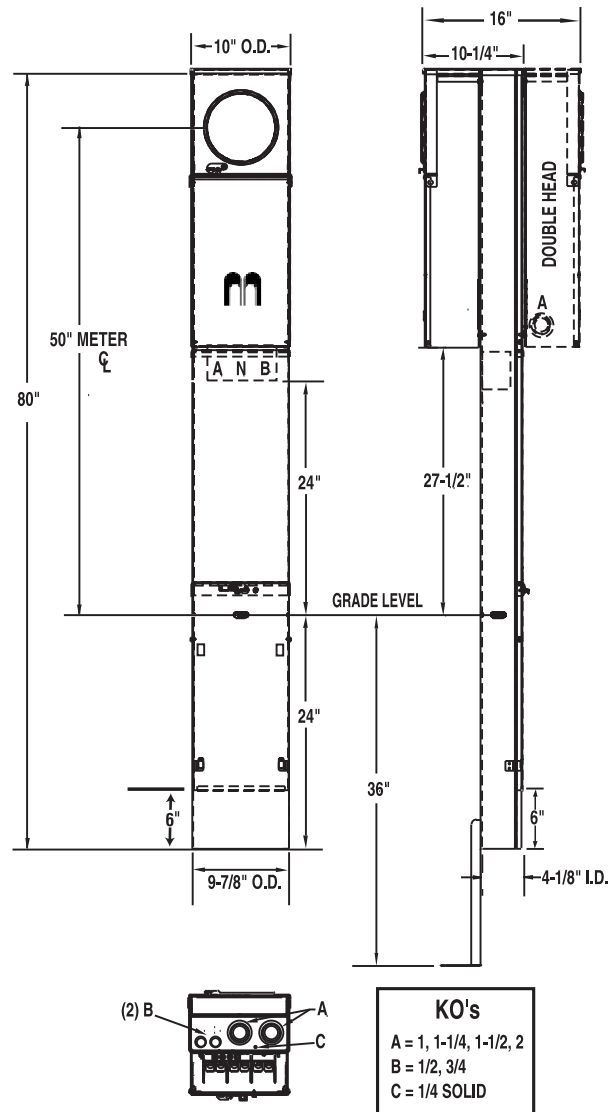

SPECIFICATIONS

- UL listed File E90945
- 200 amp maximum, 120/240 volt, single phase, three wire meter socket
- Ringless meter socket with horn bypass and stainless steel latch
- Short circuit withstand rating 22K AIC
- Type 3R construction for durable outdoor use, one piece post – lockable and sealable
- Milbank grey polyester powder coat finish
- Wire terminations accept copper or aluminum conductors
- Line & Neutral: (2) #6-350 kcmil per phase
- Line Ground: (4) #14-1/0
- Load (CB): 2/0 to 300 kcmil per pole
- Load Neutral: (1) #6-350 kcmil
- Load Ground: (2) #14-1/0, (4) #14/6
- Milbank plug-in main circuit breaker. Available in 100, 125, 150 & 200 amp. Type UQFPH-M.
- Four-circuit plated copper interior accepts (2) 2-pole or (4) 1-pole standard plug-in type circuit breakers up to a total of 125 amps maximum. Acceptable manufacturers: Cutler-Hammer, GE or Siemens
- Factory or field installable receptacle bridge and receptacle / circuit breaker kits available. See accessories.

Utility requirements for this equipment may vary. Always consult the serving utility for their requirements before ordering or installing equipment in this catalog.



SEE INDEX ON PAGE 32 FOR UTILITY APPROVALS
SINGLE PEDESTAL (Direct Burial)

CATALOG NUMBER	MAIN BREAKER	MAIN CB	BRANCH	WEIGHT (lbs)
◆ U5136-O-100S	◆ UQFPH-M-100	100	4 Circuit	82
◆ U5136-O-200S	◆ UQFPH-M-200	200	4 Circuit	82
◆ U5136-O (parallel wired)	provision for UQFPH-M Series	—	4 Circuit	80
◆ U5701-O-5T9	UQFP-M-(AMP)	100	4 Circuit	89

SINGLE PEDESTAL (Pad Mount)

U5138-O-200S	UQFPH-M-200	200	4 Circuit	82
U5138-O (parallel wired)	provision for UQFPH-M Series	—	4 Circuit	80

DOUBLE PEDESTAL (Direct Burial)

◆ U5137-O-100S	(2) UQFPH-M-100	100	4 Circuit	115
◆ U5137-O-200S	(2) UQFPH-M-200	200	4 Circuit	115
◆ U5137-O (parallel wired)	provision for (2) UQFPH-M Series	—	4 Circuit	111
◆ U5702-O-5T9	UQFP-M-(AMP)	100	4 Circuit	94

RECEPTACLE / CIRCUIT BREAKER KITS AND ACCESSORIES (order separately)

CATALOG NUMBER	DESCRIPTION
◆ K5400-BRIDGE-2POS	Self-grounded two position receptacle bridge with hardware
◆ K5415	Stabilizer Foot with hardware
◆ K5035	Pad Mount Kit with hardware for U5242/43 pad mount pedestals required
◆ K5T	5th Terminal for 208y / 120 volt 3-wire service
◆ K5193	Bus kit to convert series-wired main breaker to parallel
◆ K5194	Wire kit to convert parallel-wired main breaker to series
◆ K3450	Telephone / CATV mounting bracket (mounts left or right)
◆ K5039	Penta bolt utility cover
◆ Z708080-MO	20A duplex GFI receptacle, NEMA type 520
◆ 701776-MO	30A receptacle, NEMA type TT30R
◆ Z708767-MO	50A receptacle, NEMA Type 14-50R
◆ Q120	20A 1P circuit breaker
◆ Q130	30A 1P circuit breaker
◆ Q250	50A 2P circuit breaker
◆ K5935-10GR	Receptacle plate; 10, 10GR configurations
◆ K5935-11GR	Receptacle plate; 11GR, 11GB, 55GBGB configurations
◆ K5935-36GR	Receptacle plate; 36GR, 36GBGR configurations
◆ K5935-41	Receptacle plate; 41, 41GB, 41GBGB 55, 55GB, 55GBGR, 55GR configurations
◆ K5935-54	Receptacle plate; 54, 30 configurations
◆ K5935-2/1450	Receptacle plate; 2/1450 configuration
◆ Z819294-SC	U5136, U5240, U5701 dead front with opening for two receptacles - MH product
◆ 1148210	U5136, U5240, U5701 dead front with opening for three receptacles

- Up to two receptacle / circuit breaker kits can be field-installed in each powerhead. Order mounting bridge and receptacle kits separately from above. For three receptacles or factory-installed kits, contact factory.
- Receptacle / circuit breaker kits include receptacle, circuit breaker, connected wire, cover plate and mounting screws. Other receptacle / circuit breaker kits available.
- **K5415** Stabilizer Foot sold separately. Recommended for double pedestals.
- Pad mount pedestals require **K5035** pad mount kit. Order separately.

◆ Stock item – availability subject to prior sale. Non-stock items – minimum order quantity required.

Utility requirements for this equipment may vary. Always consult the serving utility for their requirements before ordering or installing equipment in this catalog.



CENTRAL HUDSON APPROVED ONLY



U4493-XL

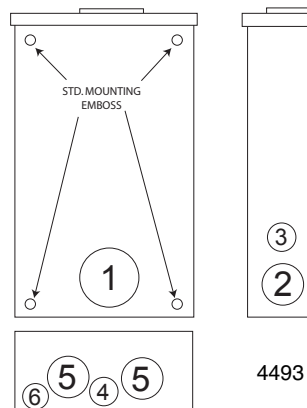

4493

80 AMP TRANSFORMER RATED-13 TERMINAL-LEVER BYPASS-RINGLESS

SERVICE	CATALOG NUMBER	HUB	CONNECTORS CU	BY-PASS	DIMENSIONS			CONCENTRIC K.O.'S					
					D"	W"	H"	1	2	3	4	5	6
OH / UG	U4493-XL	C.P.	#14 - #4 MAX	LEVER	4 ⁷ / ₈	10	18 ¹ / ₂	3	1 ¹ / ₂	³ / ₄	³ / ₄	1 ¹ / ₂	¹ / ₄

HUBS: For proper hub selection see the hub suffix chart.

BY-PASS: Lever operates current bypass device and also supplies clamping action on current meter spades.

CONNECTORS: Units are supplied with mechanical type connectors (#4 max.)



Utility requirements for this equipment may vary. Always consult the serving utility for their requirements before ordering or installing equipment in this catalog.

SEE INDEX ON PAGE 32 FOR UTILITY APPROVALS
CENTRAL HUDSON APPROVED ONLY

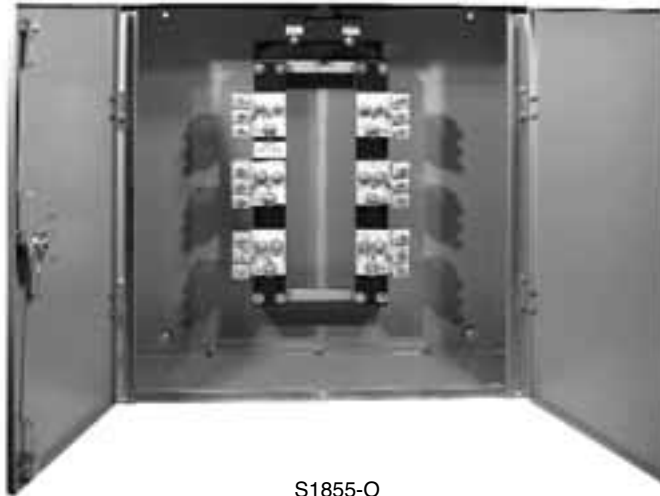

S1855-O

These enclosures have three point locking handles, lift off hinges with stainless steel pins and two doors.

CURRENT TRANSFORMER ENCLOSURE-NOT UL LISTED
CENTRAL HUDSON APPROVED ONLY

AMPERAGE RATING	CATALOG NUMBER	HUB	GAUGE STEEL	CONNECTORS CU/AL	DIMENSIONS		
					D"	W"	H"
400-800	S1855-O	BLANK	12	#3-750 kcmil PER PHASE	12	36	36
800-1200	S1856-O	BLANK	12	#5-750 kcmil PER PHASE	12	48	48

CT ENCLOSURES / CT RATED SOCKETS-600 VAC-CT3R-CURRENT TRANSFORMER CABINET / PANEL ENCLOSURE-TYPE 3R

Utility requirements for this equipment may vary. Always consult the serving utility for their requirements before ordering or installing equipment in this catalog.

SEE INDEX ON PAGE 32 FOR UTILITY APPROVALS

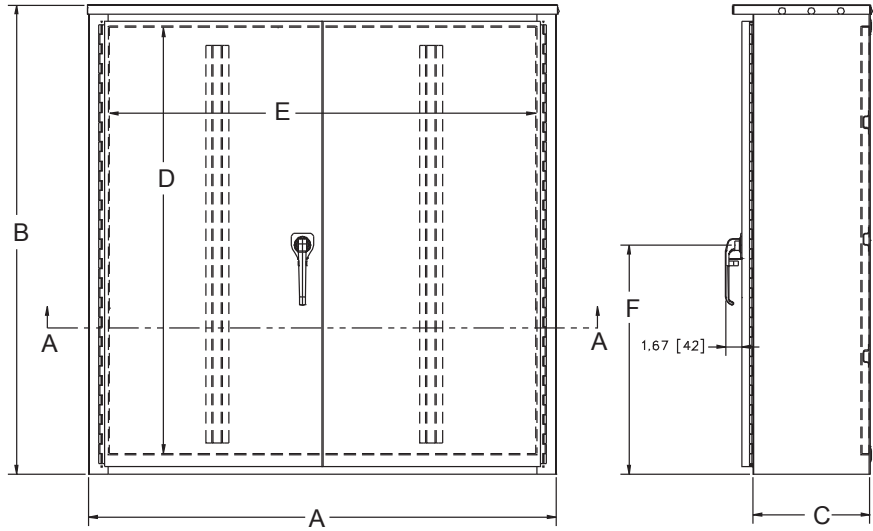

Industry Standards

- NEMA—Type 3R
- UL 50—Type 3R
- CUL—Type 3R (Equivalent to CSA)

Application

- Designed for use as a current transformer cabinet or panel enclosure
- For outdoor use to provide protection against rain, sleet, and snow, or indoor use to protect against dripping water

Construction

- Enclosure and cover manufactured from 16 or 14 gauge G90U galvanized steel, panels are 10 or 12 gauge, painted white
- The doors are overlapping with no center post
- Continuous door hinge with stainless steel hinge pins
- Three point pad-lockable handle
- Panel mounting studs provided for optional back panels
- Drip shield top and seam free sides, front and back

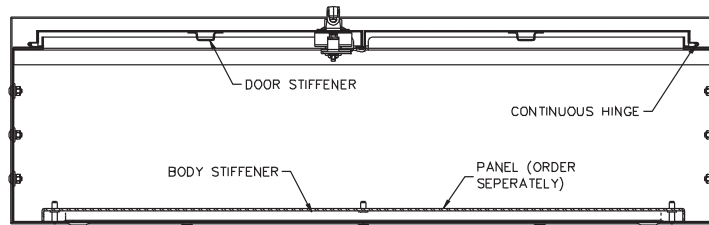

P SERIES PANELS

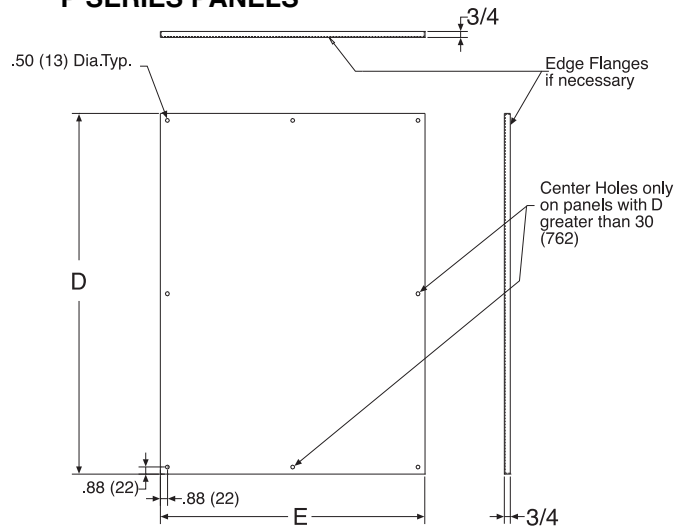

CATALOG NO.	W X H X D	P SERIES PANEL CATALOG NO.	PANEL SIZE
363010-CT3R	36 x 30 x 10	A-36P30	36 x 30
363016-CT3R	36 x 30 x 16	A-36P30	36 x 30
363610-CT3R	36 x 36 x 10	A-36P36	36 x 36
363612-CT3R	36 x 36 x 12	A-36P36	36 x 36
363616-CT3R	36 x 36 x 16	A-36P36	36 x 36
483616-CT3R	48 x 36 x 16	A-48P36	48 x 36
484812-CT3R	48 x 48 x 12	A-48P48	48 x 48
606013-CT3R	60 x 60 x 13	A-60P60	60 x 60

Utility requirements for this equipment may vary. Always consult the serving utility for their requirements before ordering or installing equipment in this catalog.



**SEE INDEX ON PAGE 32 FOR UTILITY APPROVALS
NATIONAL GRID APPROVED ONLY**

CURRENT TRANSFORMER ENCLOSURE – NATIONAL GRID APPROVED



**CURRENT TRANSFORMER ENCLOSURE
NATIONAL GRID APPROVED ONLY**

120/240 VOLT SINGLE PHASE–208Y/120 VOLT & 480/277 VOLT THREE-PHASE

AMPERAGE RATING	CATALOG NUMBER	HUB	GAUGE STEEL	STEEL BACK PANEL	DIMENSIONS		
					D"	W"	H"
400-800	363610-TC3R-H-BP-SP	BLANK	16	INSTALLED	10	36	36

Utility requirements for this equipment may vary. Always consult the serving utility for their requirements before ordering or installing equipment in this catalog.



INTERCHANGEABLE UNIT HUBS



HUB ADAPTER PLATE
(Converts 4" opening to 2½")
S8324



SMALL "RL" OPENING (STANDARD)

SUFFIX	SIZE	MILBANK NO.
WL	1"	A7514
YL	1¼"	A7515
ZL	1½"	A7516
DL	2"	A7517
EL	2½"	A7518



REMOVABLE HUB CLOSING PLATE

LARGE "R" OPENING (HEAVY DUTY)

SUFFIX	SIZE	MILBANK NO.
F	3"	A8110
G	3½"	A8111
H	4"	A8112

DESCRIPTION	SUFFIX	CAT. #
STANDARD (for -RL opening)	-XL	A7551
LARGE (for -R opening)	-X	A9064

CLOSING COVERS



METER CLOSING PLATE
(Ring type / Ringless)
6003 (Gray Plastic)
6116 (Clear Plastic)



METAL CLOSING PLATE
(For Ringless sockets)
CP-21

HUB SUFFIX CHART

O	Plain Top	WL	1"	For -RL Opening
RL	Small Hub Opening	YL	1¼"	For -RL Opening
R	Large Hub Opening	ZL	1½"	For -RL Opening
XL	Small Closing Plate	DL	2"	For -RL Opening
X	Large Closing Plate	EL	2½"	For -RL Opening
RXL	Large Hub Opening adapted to small Closing Plate	F	3"	For -R Opening
		G	3½"	For -R Opening
RRL	Large Hub Opening adapted to small Hub Opening	H	4"	For -R Opening

CONNECTOR KITS



SINGLE

For use with 3/8"-16 stud type units only



TWIN

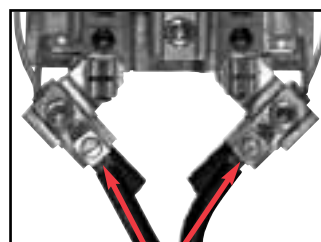

TAP CONNECTORS (3 per set)

Replaces the **line or load-side** slide-in nut assembly on Milbank 200 amp sockets. Allows for a 100 amp tap location in addition to the #6-350 kcmil load-side connector. **K5022** Includes Safety Barrier Extensions- for applications over 300 VAC.

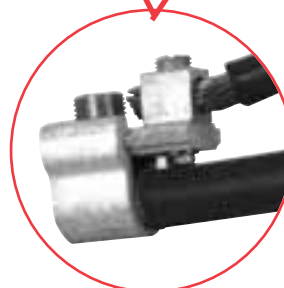

- K4977-INT**
- INTERNAL HEX
- K5022-INT**
- INTERNAL HEX

SUFFIX	CATALOG #	(3 per set) - 1 Ø
K1	K1539	6-350 kcmil
K3	K1540	4-600 kcmil or (2) 1/0-250 kcmil
K3L	K1540L	4-600 kcmil or (2) 1/0-250 kcmil Non-rotating
SUFFIX	CATALOG #	(4 per set) - 3 Ø
K5	K3082	6-350 kcmil
K7	K3441	4-600 kcmil or (2) 1/0-250 kcmil

SUFFIX	CATALOG #	(3 per set) - 1 Ø
K2	K1350	6-350 kcmil
K2L	K1350L	6-350 kcmil Non-rotating
K4	K1541	4-600 kcmil
SUFFIX	CATALOG #	(4 per set) - 3 Ø
K6	K3442	6-350 kcmil
K8	K3083	4-600 kcmil

Utility requirements for this equipment may vary. Always consult the serving utility for their requirements before ordering or installing equipment in this catalog.

FIFTH TERMINALS

Consult factory for 5th terminal selection



**100-200 amp
"PLUG-IN" FIFTH TERMINAL
5T8K2**



**HEAVY DUTY JAW
CLAMPING
K3865
(K3866 w/out neutral wire)**

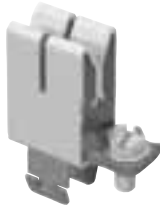

**200 amp
FIFTH TERMINAL
K5T
(New style block with square hole)**



**FOR CONDO
METERING BANKS
(125-200 amp)
K2381**

ANTI-INVERSION CLIP



K4802

BYPASS LINK



**K8180
(Bypass links sold in pairs)**

DISCONNECT SLEEVE *

M5-144
(*NOT TO BE USED WITH LEVER
BYPASS SOCKETS)



TRIPLEX GROUND



**K1190
(For factory installed triplex
ground add suffix "-TG" to the
catalog number.)**

SEALING RINGS



**SNAP ACTION
MR-2**

**SCREW TYPE
(Stainless Steel)
MR-4**

**STAINLESS STEEL
MR2-SS**

ISOLATED NEUTRAL KIT

K1047

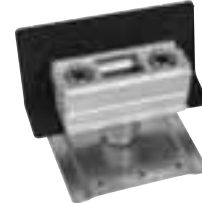

PLUG-IN BREAKER COMPATIBILITY CHART

AMPS	MILBANK	CUTLER-HAMMER (WESTINGHOUSE)	SIEMENS (ITE)	SIEMENS MURRAY / CROUSE-HINDS	G.E.	SQ-D
125-200	Q / QN	HQP / BR / WBJ	Q / QN	MD	THQ	—
≤ 100	Q	QP / BR / HQP	QP	MP	THQ	HOMELINE

Utility requirements for this equipment may vary. Always consult the serving utility for their requirements before ordering or installing equipment in this catalog.

MAXIMUM NUMBER OF CONDUCTORS IN CONDUIT ♦

Table from 2008 NEC Code Reference: Rigid Metal Conduit

TYPE	CONDUCTOR SIZE (AWG / kcmil)	CONDUIT TRADE SIZES (INCHES)									
		1/2	3/4	1	1 1/4	1 1/2	2	2 1/2	3	3 1/2	4
THHN, THWN, THWN-2	12	9	16	26	46	62	102	146	225	301	387
	10	6	10	17	29	39	64	92	142	189	244
	8	3	6	9	16	22	37	53	82	109	140
	6	2	4	7	12	16	27	38	59	79	101
	4	1	2	4	7	10	16	23	36	48	62
	3	1	1	3	6	8	14	20	31	41	53
	2	1	1	3	5	7	11	17	26	34	44
	1	1	1	1	4	5	8	12	19	25	33
	1/0	1	1	1	3	4	7	10	16	21	27
	2/0	0	1	1	2	3	6	8	13	18	23
3/0	0	1	1	1	3	5	7	11	15	19	
4/0	0	1	1	1	2	4	6	9	12	16	
XHH, XHHW, XHHW-2	4	1	2	4	7	10	16	24	37	49	63
	2	1	1	3	5	7	12	17	26	35	45
	1/0	1	1	1	3	4	7	10	16	22	28
	2/0	0	1	1	2	3	6	9	13	18	23
	4/0	0	1	1	1	2	4	6	9	12	16
	250	0	0	1	1	1	3	5	7	10	13
	350	0	0	1	1	1	2	3	6	7	10
500	0	0	0	1	1	1	2	4	5	7	
750	0	0	0	0	1	1	1	3	4	5	

♦ This table is for concentric stranded conductors only. For cables with compact conductors refer to NEC. Refer to latest NEC Code or Local Codes for updated requirements.

*** ALLOWABLE AMPACITIES OF INSULATED COPPER & ** ALUMINUM CONDUCTORS (3W IN CONDUIT) 75°C (167°F)**

*CU		AL or **Cu-Clad AL	
A	B	A	C
18	-	-	-
16	-	-	-
14	20†	-	-
12	25†	12	20†
10	35†	10	30†
8	50	8	40
6	65	6	50
4	85	4	65
3	100	3	75
2	115	2	90
1	130	1	100
1/0	150	1/0	120
2/0	175	2/0	135
3/0	200	3/0	155
4/0	230	4/0	180
250	255	250	205
300	285	300	230
350	310	350	250
400	335	400	270
500	380	500	310
600	420	600	340
700	460	700	375
750	475	750	385

A = Size: AWG/MCM
***B** = Ampere Rating for Insulation Types:
FEPW, RH, RHW, THW, THWN, XHHW, USE, 2W.
****C** = Ampere Rating for Insulation Types:
RH, RHW, THW, THWN, XHHW, USE
 (Per NEC table 310-16)

AMPACITY CORRECTION FACTORS

AMBIENT TEMP. C°	CORRECTION FACTOR	AMBIENT TEMP. F°
21 - 25	1.05	70 - 77
26 - 30	1.00	78 - 86
31 - 35	.94	87 - 95
36 - 40	.88	96 - 104
41 - 45	.82	105 - 113
46 - 50	.75	114 - 122
51 - 55	.67	123 - 131
56 - 60	.58	132 - 140
61 - 65	.33	141 - 158

Overall ampere ratings of U/L listed Milbank multiple position meter sockets are based on **2008 N.E.C. Handbook Article 220-84** and **ANSI / UL-414** (except where restricted by line connector size.) These requirements provide for a diversity factor / demand factor being utilized in determining the overall (main bus / lug) rating of a gang socket. All Milbank U/L listed gang sockets meet or exceed these diversity factor/demand factor requirements. Standard overall ampacity ratings for U/L listed and non U/L listed gang sockets are as shown in the chart below. Ampere ratings of meter sockets are based on the meter socket being wired with 75° C insulated wire conductor, sized in accordance with **Table 310-16** of the **National Electric Code**.

GANG SOCKET OVERALL AMPACITIES

NO. OF METER POSITIONS	100A / POS. AMPACITY	125A / POS. AMPACITY	150A / POS. AMPACITY	200A / POS. AMPACITY
2	200A	200A	200A	400A
3	200A	225A	225A	270A
4	200A	250A	270A	360A
5	225A	285A	338A	450A
6	270A	330A	396A	528A

† Unless otherwise permitted elsewhere in the Code, the overcurrent protection for conductor types marked with an obelisk (†) shall not exceed 15 amps for 14 AWG, 20 amps for 12 AWG, and 30 amps for 10 AWG copper; or 15 amps for 12 AWG and 25 amps for 10 AWG aluminum and copper-clad aluminum after any correction factors for ambient temperature and number of conductors have been applied.

IMPORTANT NOTE

In addition to national and local electrical codes, many utilities have specific requirements for metering equipment. Always consult the serving utility for their specifications and requirements prior to ordering or installing Milbank meter mounting equipment.

BEFORE ENERGIZING

- A. Give equipment a thorough visual examination to determine that:
 - 1) No shipping or installation damage exists.
 - 2) Proper clearances have been maintained.
 - 3) All connections have been made.
 - 4) Equipment is clean and dry.
- B. Make a thorough examination to:
 - 1) Verify tightness of all bolted connections (see table below).
 - 2) Manually operate all circuit breakers, switches, relays, etc.
 - 3) Check rigidity of all mountings, bus bars and components.
 - 4) Use test equipment to check continuity of circuitry and integrity of insulation.
- C. All switches and circuit breakers should be in the “off” position.
- D. Verify that manual meter bypass (if applicable) is in non-bypass position.
- E. Install cover and/or close doors.
- F. If installation is not being energized at this time, follow “after-energizing” steps listed below. These steps will secure the installation in case of accidental energization.

WHEN ENERGIZING

- A. Use caution and follow established safety procedures:
 - 1) Wear safety apparel.
 - 2) Use safety equipment.
 - 3) Take action to prevent injury to yourself and others in the event of failure of the installation.
 - 4) Take action to prevent/decrease damage to property in the event of failure of the installation.
 - 5) If you are unsure how to safely energize the installation, get someone who is knowledgeable to do it.

AFTER ENERGIZING

- A. Secure the installation:
 - 1) To prevent accidental contact with energized parts, cover all openings with approved filler devices.
 - 2) To prevent unauthorized access, secure all covers and/or doors with approved security devices.
 - 3) Attach/post information to advise others of potential hazards associated with the installation.

RECOMMENDED TORQUE FOR GENERAL APPLICATIONS*

NOMINAL SIZE	JOINT DESCRIPTION		HEAD TYPE	TORQUE (INCH LBS.)
	SCREW	NUT		
10	BRASS	Brass Nut or Extruded Hole	ALL	20-25 in. lbs.
10	STEEL	CU or AL Busbar $\leq 1/8"$	ALL	25-30 in. lbs.
10	STEEL	Steel Nut or EH; CU or AL Busbar $> 1/8"$	ALL	30-35 in. lbs.
12	STEEL	Aluminum Extruded Hole	ALL	30-35 in. lbs.
12	STEEL	Steel Nut or Extruded Hole	ALL	40-50 in. lbs.
1/4	STEEL	Aluminum Extruded Hole	ALL	40-50 in. lbs.
1/4	STEEL	Steel Nut or EH; CU or AL Busbar	ALL	50-60 in. lbs.
5/16	STEEL	Aluminum Extruded Hole	HEX	60-70 in. lbs.
5/16	STEEL	Steel Nut or EH; CU or AL Busbar	HEX	100-150 in. lbs.
3/8	STEEL	Steel Nut	HEX	150-200 in. lbs.
1/2	STEEL	Steel Nut	HEX	200-250 in. lbs.

*Interior labels typically indicate the required torque for wire connectors and studs, and should be referenced first.

EH: Extruded Hole

CU: Copper

AL: Aluminum

MATERIALS

STEEL QUALITY

The meter equipment listed in this catalog is made of galvanized steel (AISI* G90) to afford the best possible weather proofing. *American Iron and Steel Institute.

STEEL SHEET

16 gauge, galvanized, sheet: 0.90 oz./sq.ft. class zinc-coated.
(AISI G90)
14 gauge, galvanized, sheet: 0.90 oz./sq.ft. class zinc-coated.

ALUMINUM EXTRUSION

Wire-Terminals: Alloy; 6061-T6, Tin-plated for CU/AL wire.
Bus Bar: Alloy; 6101-o & 6063-O

ALUMINUM SHEET

3000 series aluminum sheet, H14, or 5052 series aluminum sheet, H32. Where applicable thicknesses range from .064 — .125

COPPER SHEET & BUS

Electrolytic copper with tin plating in most applications.

INSULATING MATERIALS

- In most units, support bases for current-carrying components are molded from fiberglass reinforced high-strength, track resistant, thermoset polyester molding compounds.
- Clear or black safety shields and polarity barriers are molded from high-strength, track resistant, polycarbonate molding compounds.
- Various sheet insulating materials, as appropriate for the application are utilized in the fabrication of flat, formed and punched component parts and barriers.

FINISH

PROCESS

Light gray "state of the art" electrostatically applied powder paint offers a durable, non-fading finish. For further information concerning the chemical analysis of the weather resistant finish, please contact the factory.

METAL FASTENERS

Zinc-coated with a chromate dip.

RATING

NEMA RATING

All Milbank meter sockets, CT cans and meter socket / breaker units have a type 3R rating.

DIAGRAM A

1 \emptyset 2W with 1 P.T. & 1 C.T.
Single Stator Meter(2W1 \emptyset) - Form 3S
5T Socket, Test Switch #TS04-0101

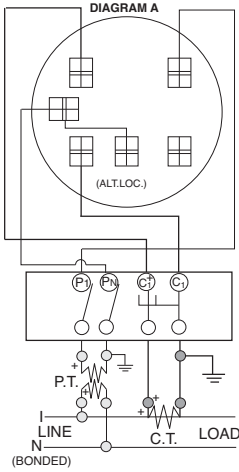

DIAGRAM B

1 \emptyset 3W with 1 C.T.
Single Stator Meter(2W1 \emptyset) - Form 3S
5T Socket, Test Switch #TS04-0101

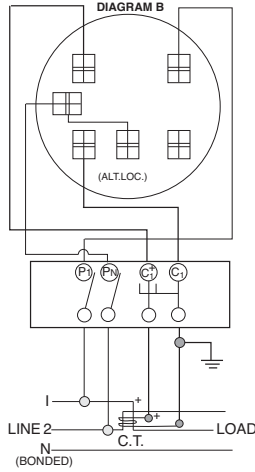

DIAGRAM C

1 \emptyset 3W with 2 C.T.'s
Single Stator Meter(3W1 \emptyset) - Form 4S
6T Socket, Test Switch #TS07-0105

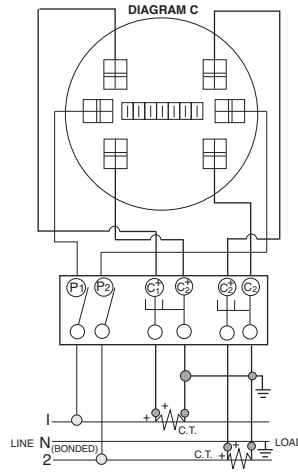

DIAGRAM D

1 \emptyset 3W or 3W Network with 2 C.T.'s
2 Stator Meter - Form 5S
8T Socket, Test Switch #TS07-0105

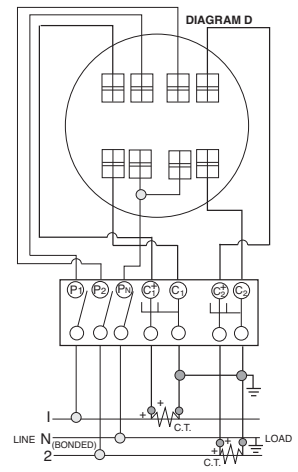

DIAGRAM E

3 \emptyset 3W "A" with 2 P.T.'s & 2 C.T.'s
2 Stator Meter - Form 5S
8T Socket, Test Switch #TS07-0105

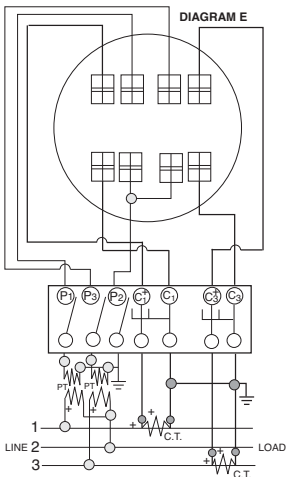

DIAGRAM F

3 \emptyset 3W "A" with 2 C.T.'s
2 Stator Meter - Form 5S
8T Socket, Test Switch #TS07-0105

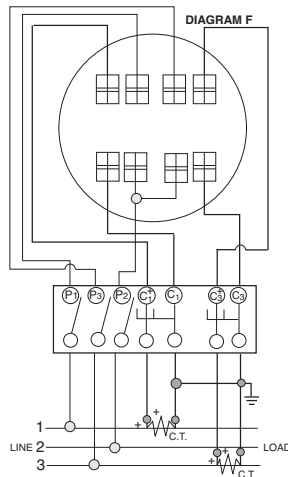

DIAGRAM G

3 \emptyset 4W "Y" with 3 C.T.'s
2 1/2 Stator Meter - Form 6S
13T Socket, Test Switch #TS10-0109

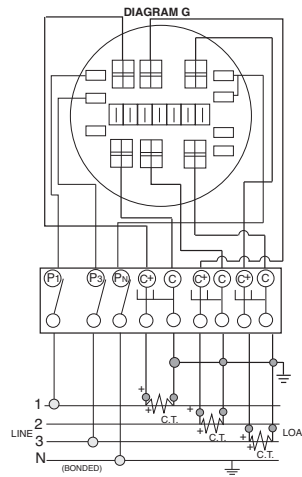

DIAGRAM H

3 \emptyset 4W "Y" with 2 P.T.'s & 3 C.T.'s
2 1/2 Stator Meter - Form 6S
13T Socket, Test Switch #TS10-0109

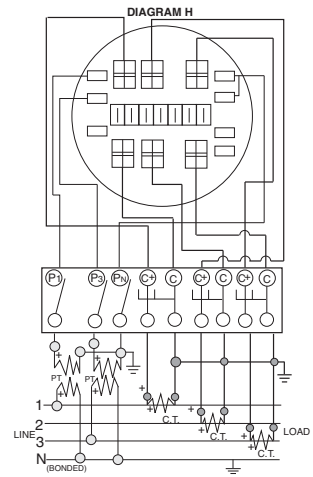

DIAGRAM I

3 \emptyset 4W "Y" or "A" with 3 C.T.'s
"Y" 3 Stator Meter - Form 9S
"A" 2 Stator Meter - Form 8S
13T Socket, Test Switch #TS10-0109

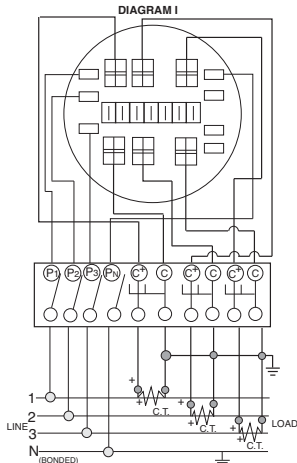
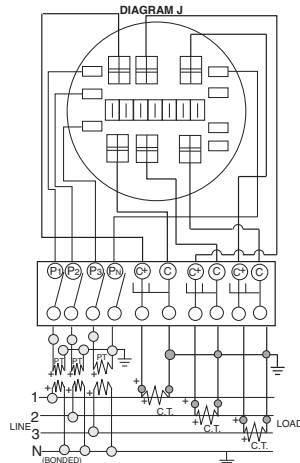

DIAGRAM J

3 \emptyset 4W "Y" with 3 P.T.'s & 3 C.T.'s
3 Stator Meter - Form 9S
13T Socket, Test Switch #TS10-0109



PREWIRING: If standard factory prewiring is required, refer to wiring diagrams on this page. Determine appropriate diagram and send a copy with order. If custom factory prewiring is required, specify on order. Be sure to include meter socket catalog number, test switch make and catalog number, meter form number and provide a copy of your wiring diagram.

NUMERIC INDEX & UTILITY APPROVALS

CAT. NO	C.H.	NYS EG	Nat'l. Grid NY	RGE	PG#	CAT. NO	C.H.	NYS EG	Nat'l. Grid NY	RGE	PG#
U4175-RL-BLG			•		9	U2863-X			•	•	16
U7021-RL-TG-KK-RGE		•	•	•	10	U2864-X			•	•	16
U7040-RL-TG-KK-RGE	•	•		•	10	U2865-X			•	•	16
U7487-RL-TG-KK	•	•			10	U2866-X			•	•	16
U9090-O			•		11	U1252-R-KK-RGE	•	•	•	•	17
U5168-XTL-100-KK-PL*	•	•	•	•	12	U1253-R-KK-RGE	•	•	•	•	17
U5168-XTL-200-KK-PL*	•	•	•	•	12	U1254-R-KK-EX-RGE	•	•	•	•	17
U9551-RXL	•				13	U1255-R-KK-EX-RGE	•	•	•	•	17
U9801-R	•				13	U1256-R-KK-EX-RGE	•	•	•	•	17
U9551-RL				•	13	U2732-XT			•		18
U2046-O			•		14	U2733-XT			•		18
U2047-O			•		14	U2734-XT			•		18
U2048-RL	•				13, 14	U2735-XT			•		18
U2049-RL			•		14	U2736-XT			•		18
U9701-R	•				14	U2872-XT			•		18
U2448-X-RGE	•		•	•	15	U2873-XT			•		18
U2594-X	•		•	•	15	U2874-XT			•		18
U4013-X			•	•	15	U2875-XT			•		18
U5161-X			•	•	15	U2876-XT			•		18
U2852-X			•		16	U4093N-O			•	•	19
U2853-X			•		16	U5136-O			•		20
U2854-X			•		16	U4493-XL	•				22
U2855-X			•		16	S1855-O	•				23
U2856-X			•		16	S1856-O	•				23
U2862-X			•	•	16	363610-TC3R-H-BP-SP			•		25

Cat. No.	Pg. No.	Cat. No.	Pg. No.	Cat. No.	Pg. No.
363010-CT3R	24	K3082	26	U2856-X	16
363010-TC3R-H-BP-SP	25	K3083	26	U2864-X	16
363016-CT3R	24	K3441	26	U2865-X	16
363610-CT3R	24	K3442	26	U2866-X	16
363612-CT3R	24	K3865	8, 27	U2872-XT	18
363616-CT3R	24	K3866	27	U2873-XT	18
483616-CT3R	24	K4802	27	U2874-XT	18
484812-CT3R	24	K4977-INT	26	U2875-XT	18
5T8K2	27	K5022-INT	26	U2876-XT	18
6003	26	K5035	21	U3802	5
606013-CT3R	24	K5193	21	U3832	5
6116	26	K5400-1450	21	U3860	5
A-36P30	24	K5400-520	21	U3822-20GWR	6
A-36P36	24	K5400-520GR	21	U4013-X	15
A-48P36	24	K5400-BRIDGE-1POS	21	U4093N-O	19
A-48P48	24	K5400-BRIDGE-2POS	21	U4175-RL-BLG	9
A-60P69	24	K5400-TT30	21	U4493-XL	22
A7514	26	K5415	21	U4881-O	6
A7515	26	K5T	27	U4881-O-50GB	6
A7516	26	K8180	27	U4881-O-60GB	6
A7517	26	M5-144	27	U5136-O-100S	20, 21
A7518	26	MCP	26	U5136-O-200S	20, 21
A7551	26	MR-2	27	U5137-O-100S	20, 21
A8110	26	MR-2SS	27	U5137-O-200S	20, 21
A8111	26	MR-4	27	U5161-X	15
A8112	26	S1855-O	23	U5168-XTL-100-KK	12
A9064	26	S1856-O	23	U5168-XTL-150-KK	12
CP-21	26	U1252-R-KK-RGE	17	U5168-XTL-200-KK	12
CP-ABK5/8	8	U1253-R-KK-RGE	17	U5168-XTL-100-KK-PL	12
CP-TC7D	8	U1254-R-KK-EX-RGE	17	U5168-XTL-200-KK-PL	12
CP-TC24H	8	U1255-R-KK-EX-RGE	17	U5268-XTL-150-KK	12
CP-TCWIRE	8	U1256-R-KK-EX-RGE	17	U5268-XTL-200-KK	12
CP-16PDMNT-CALT	8	U2046-O	14	U7021-RL-TG-KK-RGE	10
CP-24PDMNT-CALT	8	U2047-O	14	U7040-RL-TG-KK-RGE	10
CP-PE-HOA-3POS	8	U2048-RL	13, 14	U7487-RL-TG-KK	10
K1047	27	U2049-RL	14	U9090-O	11
K1190	27	U2448-X-RGE	15	U9551-RL	13
K1350	26	U2594-X	15	U9551-RXL	13
K1350L	26	U2732-XT	18	U9701-R	14
K1539	26	U2733-XT	18	U9801-R	13
K1540	26	U2734-XT	18		
K1540L	26	U2735-XT	18		
K1541	26	U2736-XT	18		
K2381	27	U2855-X	16		

* Approved for National Grid NY Service area – for overhead and underground when underground service is a complete cable-in-conduit system.

Other quality products available from Milbank

Commercial Pedestals

- Attractive
- Easy to install
- Secure
- Cost effective



Un-Strut Your Stuff...

816.483.5314 phone
816.483.6357 fax
www.milbankmfg.com
ComPed 2/09 (7.5K)



Milbank® Commercial and Industrial Products



Recreational Vehicle Park Electrical Products & Accessories

Voyager Series
Millennium Series



In addition to your local utility's meter mounting equipment, Milbank also manufactures supporting products, such as...

- Air Conditioner Disconnects**
- Hot Tub Disconnects**
- RV/Mobile Home Power Outlets**
- Terminal Boxes**
- Temporary Power Outlets**
- Commercial Pedestals**
- Commercial Enclosures**
- CT Enclosures**
- Circuit Breakers**
- Enclosed Circuit Breakers**
- Safety Switches**
- Test Switches**

Contact your local distributor or go to www.milbankmfg.com to find additional product literature.



Commercial Pedestal Worksheet

Phone (816)483-5314 • Fax (816)483-6357

Please answer all of the questions as best as you can. Additional comments as to application and future requirements will help Milbank will determine the best product for your job.

Distributor: _____ Phone: _____ Fax: _____

Contact Name: _____ Application: _____

Milbank Representative: _____ Salesmen: _____

Job Name & Location: _____

Agency Specifications: (DOT-City-Other) _____

Unit Amperage: _____ Voltage: _____ Phase: _____ Wire: _____

Meter socket (200 Amp) RING-TYPE RINGLESS Fifth Terminal? NO YES (at _____ o'clock)

Meter socket (200 Amp) RING-TYPE RINGLESS Fifth Terminal? NO YES (at _____ o'clock)

Main breaker requirements: Amp: _____ Poles: _____ KAIC: _____

Main breaker requirements: Amp: _____ Poles: _____ KAIC: _____

Interior #1 0-42 circuits _____ Load center _____ Panel board _____ Metered? YES NO

Interior #2 0-42 circuits _____ Load center _____ Panel board _____ Metered? YES NO

Branch breakers: Amps: Poles: KAIC: Label & Special requirements:

Qty _____ Breakers _____

Qty _____ Breakers _____

Qty _____ Breakers _____

Qty _____ Breakers _____

Qty _____ Breakers _____

Qty _____ Breakers _____

Controls:

Qty _____ Time Clock: 24 Hr _____ 7 Day _____ 365 Day Astro _____ Description: _____

Qty _____ Photo Electric Control Receptacle

Qty _____ Test switch: 2 Pos. _____ 3 Pos. _____ HOA Type _____ Other _____

Qty _____ Control Transformer _____ Voltage _____ VA Size (required for all 277/480v)

Contactors:

Type: Lighting - **LT** / Definite Purpose - **DP** / Mechanical Held - **MH** / Mercury - **MV** / IEC - **IC**

Qty _____ Type _____ Amps _____ Poles _____ Coil voltage _____ Other _____

Qty _____ Type _____ Amps _____ Poles _____ Coil voltage _____ Other _____

Qty _____ Type _____ Amps _____ Poles _____ Coil voltage _____ Other _____

Cabinet / Finish requirements: Alum – Untreated = **AO** / Alum Anodized = **AL** / Stainless Steel = **SS**

Aluminum – Painted = **A** / GALVANIZED STEEL PAINTED (STANDARD) _____ (specify paint below)

MINT GREEN (STANDARD) = **G** / Pine Green = **PG** / Dark Green = **DG** / Black = **BK** / Desert Tan = **DT**

White = **W** / Gray = **P** / Summerland Gray = **SG** / Other (RAL finish number) _____

Other Requirements: _____

Please send any drawings, plans, specifications, and load/panel board schedules with worksheet

Meter Mounting Equipment & More!

Commercial Electrical Enclosures

Residential & Commercial Metering

Commercial Meter Pedestals

Disconnect Devices

Current Transformer Enclosures

RV/MH Pedestals

Temporary Power Outlets

Circuit Breakers

Distribution Unit Substations

Enclosed Circuit Breakers

Safety Switches

Test Switches



R.D. WRIGHT, INC.

P.O. Box 130

Greenville, N.Y. 12083

Tel: 518-966-5980

Fax: 518-966-5985

MILBANK MFG. CO.

PO Box 419028

Kansas City, MO 64141-0028

Tel: 816-483-5314 Fax: 816-483-6357

Toll Free: 877-483-5314

www.milbankmfg.com

MILBANK®



www.milbankmfg.com

UNY 12/10 (1.5K)