

**Floor Boxes,
Access Floor Modules,
Poke-Through Devices**

D

Floor Boxes – Overview D2-D3
Concealed Service Floor Boxes D4-D13
Flush Service Floor Boxes D14-D32
Above Floor Service Fittings D33
Floor Box Replacement Parts and
Accessories D34-D37
Floor Box Selection Chart D38
Floor Box Cover Selection Chart D39
Floor Box Covers D40
Specifications D41-D42
Access Floor Modules D43-D50
Specifications D51
Recessed Poke-Through System D52-D53
Modular Poke-Through System D54-D57
Specifications D58

Steel City®

Floor Boxes – Overview

D
Steel City®

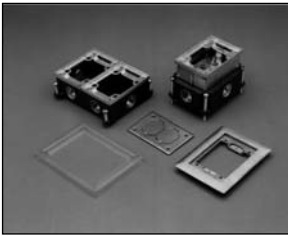

840, 640 Series—
Flush Multiple Service



665-SC



P60 Series—power application

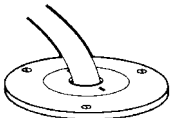

P60 Series—Communication/Data Application

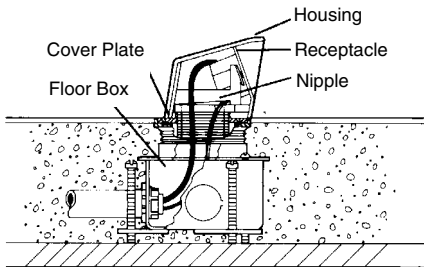

Floor Box Systems

The aesthetic and technical needs of today's buildings are as diverse as the equipment that fills them. Small wonder, then, that floor boxes can continue to solve the needs of today and the future as they did in the early 1900's when they were invented. They are still a contemporary, capable and cost-effective wire management system. Steel City, a pioneer in both the design and application of floor boxes since 1904, invites you to discover, or rediscover, the possibilities.

Three Levels of Service

Concealed Service

All power, communications and data devices are hidden below the finish floor level.



664 Series

Flush Service

All power devices are mounted at the finish floor level.



600 Series

Above Floor Service

All power devices are mounted in a service fitting head above the finish floor.



SFH-40 Series

Multiple Service Capabilities Power, Communications and Data in One Unit

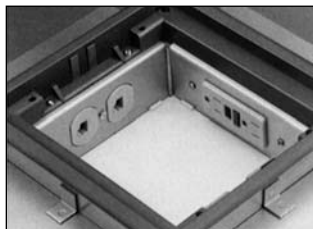

665-SC



AFM-6



664-SC

Thomas & Betts

Steel City®

Floor Boxes – Overview

Building Design Flexibility—Floor Boxes Designed for the Following Applications:



664SC
Slab on Grade
Steel Deck
With Concrete Pour



664-CI
Slab on Grade
Steel Deck
With Concrete Pour



Two Pour Concrete



Concrete
Frame



61-W
Wood Floor



62-W
Wood Floor



672
Wood Floor

New Construction or Retrofit Applications



Thomas & Betts

Steel City®

Concealed Service Floor Boxes

D

Steel City®

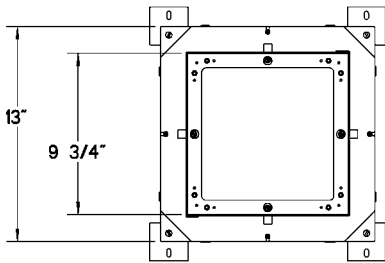
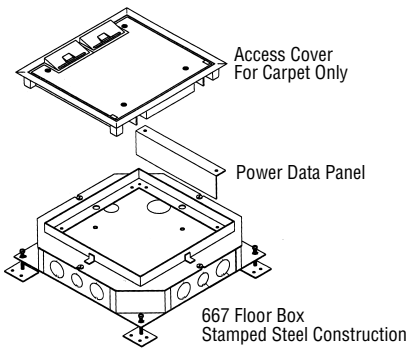

667SC Series Concealed Service Floor Box

Features and Benefits

- Largest capacity concealed service floor box on the market.
 - Four “double-gangs” allow for two duplex receptacles per gang for a total of eight receptacles per box.
 - Each gang has 40 cu. in. of capacity.
 - Box interior has 128 cu. in. of capacity.
- Standard box configuration is for up to 8 power and/or low voltage devices.
 - Box design allows for feed-through cabling for power and low voltage conductors.
- Shallow design.
 - 3" overall height is ideal for renovations and upper level floor installations.
- Full line of low profile covers.
 - Utilizes same quality cover as AFM-8 Access Floor Module.
 - Steel reinforced for added durability.
 - Two retractable cable exit ports.
 - 64 sq. in. opening provides easy access to device panels.
- 1/4" recess for carpet/tile insert.
- Available in gray, black, brown, and beige.
- Box is manufactured with (1) 3/4", (3) 1", & (1) 1-1/4" k.o.'s per gang.
 - This includes a 1" & 1-1/4" k.o. located in the bottom.
- Full complement of device panels.
 - Device panels available with one or two duplex openings, one or two GFI openings, six standard “keystone” with Omni 110 bezels and blanks.
- Provided with leveling legs and base feet.
 - Base feet can be attached to form preventing box movement during concrete pour.
 - Leveling legs provide up to 1 1/2" pre-pour adjustment.
- Manufactured from 14 gauge pre-galvanized steel.
 - Quality construction provides added durability and rust protection.

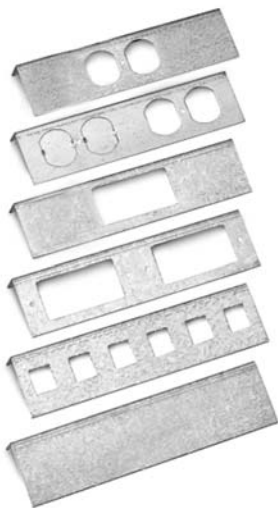
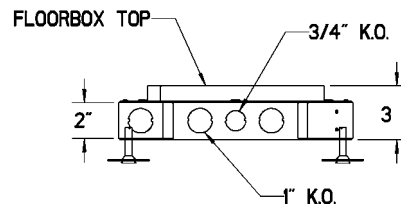
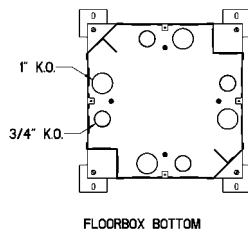

667SC Series Floor Box

Cat. No.	Description	Std. Ctn.
667-SC**	Four Gang Recessed Floor Box*	1
667-RP	Single Duplex Receptacle Plate	4
667-2RP**	Device Panel for 2 Duplex Receptacles with Duplex KOs	4
667-BP	Blank Device Panel	4
667-6RJ**	Device Panel for 6 Keystone Data Jacks	4
667-2G	Device Panel for 2 GFCI Receptacles	4
667-1G	Device Panel for 1 GFCI Receptacle	4
667-CST-GRY	Cover and Carpet Flange - Gray	4
667-CST-BLK	Cover and Carpet Flange - Black	4
667-CST-BRN	Cover and Carpet Flange - Brown	4
667-CST-BGE	Cover and Carpet Flange - Beige	4

* Supplied with (1) 667RP for 1 duplex receptacle and (1) 667BP Blank Plate.

Thomas & Betts

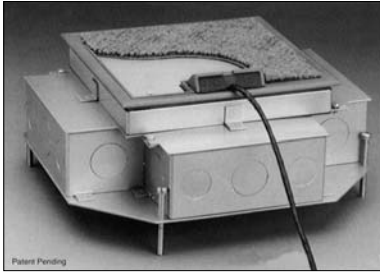

- The "665" line is an extension of the industry leading "664" series; our concealed service line now allows the customer to install up to four device panels in one box.
- Through the use of a unique nonmetallic wire tunnel the installer can easily partition his power, voice/data requirements.
- This U.L. Listed stamped steel floor box can be installed with Thomas & Betts voice and data connector products.
- The 665SC utilizes the same quality "CST" cover the industry has come to expect from the leader in concealed service floor boxes.
- Four 2½" levelling screws provided with all boxes.
- Device panels ordered separately.

665SC Series Concealed Service Floor Box

- Four (4) device compartments can accommodate any combination of devices, for example: (3) duplex power devices and (1) duplex telephone device or (2) voice and data connectors and (1) GFCI device and (1) blank, etc.
- Overall height of 3½" allows for shallow pours when needed.
- Nylon carpet flange (665-CST) cover made of resilient nylon material with a ⅝" steel plate assures structural integrity.
- Four side feed thru allows installer to feed thru power or data/comm service from any orientation.
- Nonmetallic wire tunnels aesthetically clean. Full width tunnel provides maximum feed-thru capacity; nonmetallic material prevents conductor damage.
- Total access area of 126 cu. in. allows for friendly installation of workstation cables.
- Contains 28 Knock-outs (16-1¼" and 12-¾" KOs) that provide increased flexibility when installed.

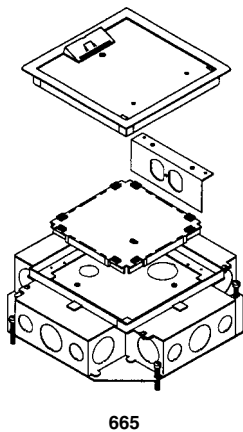
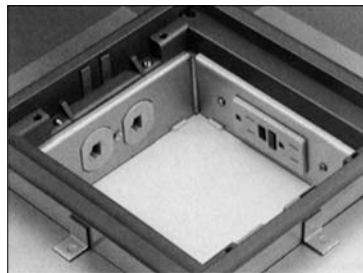

665

Series 665 Floor Box

Cat. No.	Description	Device Compartment				Device Access Area	Std. Ctn.
		Length	Width	Height	Area		
665SC	Stamped steel box	5¾ in.	2¾ in.	2½ in.	40 cu. in.	126 cu. in.	1

665SC Series floor boxes do not include device panels or covers. Order separately.
Material: Pre-Galvanized Steel

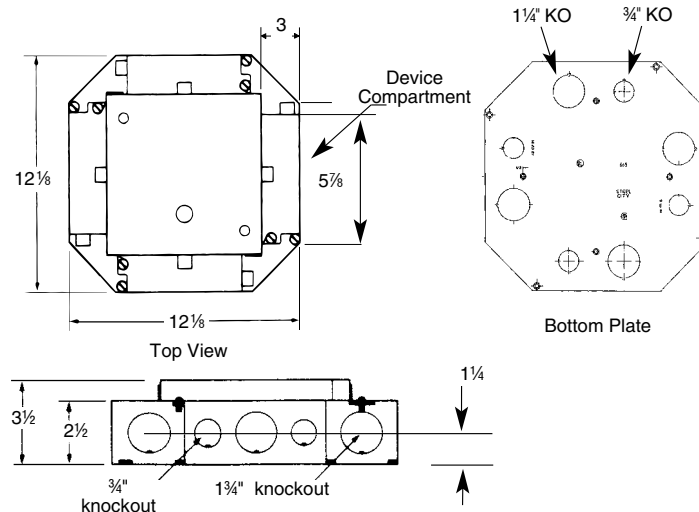

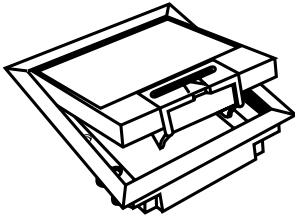

665-CST

Covers for 665SC Floor Boxes

Cat. No.	Description	Std. Ctn.
665-CST-GRY	Gray cover	4
665-CST-BRN	Brown cover	4
665-CST-BGE	Beige cover	4
665-CST-BLK	Black cover	4

Material: Nylon-6 with 5/32" Steel Plate
Furnished with 4-#8-32 x 5/8" mounting screws

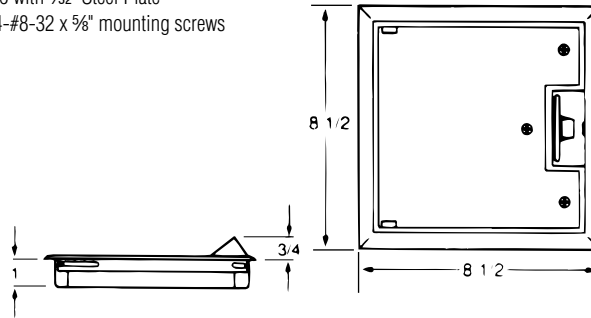

Wire Tunnel for 665SC Floor Boxes

Cat. No.	Description	Std. Ctn.
665-WT	Wire tunnel for 665 floor box	4

One provided with box. Material: PVC

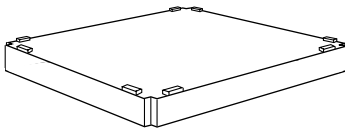

665-WT

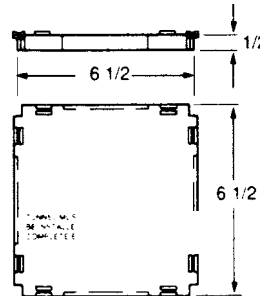

Device Panels for 665SC Floor Boxes

Cat. No.	Description	Std. Ctn.
665-RP	Receptacle plate for 665 floor box	4
665-GP	GFCI receptacle plate for 665 floor box	4
665-BP	Blank plate for 665 floor box	4
665-6RJ	Device plate for 6 Keystone Data Jacks	4
665-STEL	Telephone data plate for 665 floor box	4

Material: Pre-Galvanized Steel

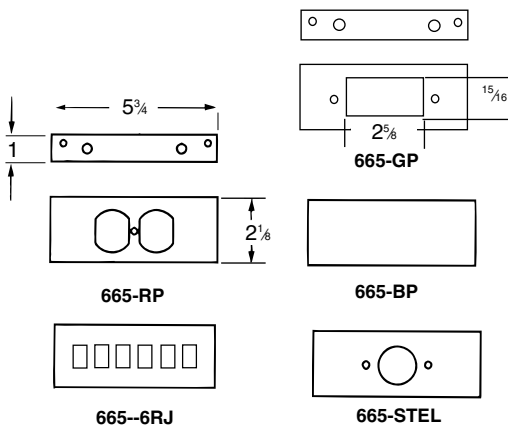

Communication Accessories

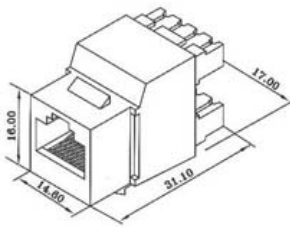

Features & Benefits

- Universal "Keystone" mounting configuration.
- Labeled for both 568A & 568B wiring.
- Versatile IDC design accommodates 110 or Krone punchdown tools.
- Narrow design for high-density applications.
- Available in a broad range of colors for installation color schemes.

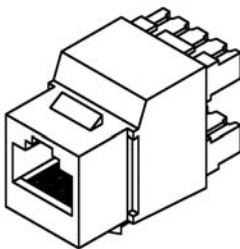
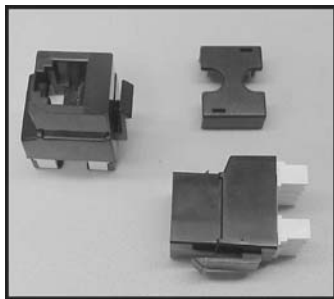

Features & Benefits

- Universal "Keystone" mounting configuration.
- Same mounting style as Cat 5e jacks for use in same faceplates.
- Versatile IDC design accommodates 110 or Krone punchdown tools.
- Available in 4 colors (shown above).

Keystone Category 5e Jacks

Cat. No.	Description	Color
OPJNUD	Cat 5e Slim-line UTP Jack, 568A/568B Wiring, Dual 110 / Krone IDC	Black
OPJNUD-IV	Cat 5e Slim-line UTP Jack, 568A/568B Wiring, Dual 110 / Krone IDC	Ivory
OPJNUDBL	Cat 5e Slim-line UTP Jack, 568A/568B Wiring, Dual 110 / Krone IDC	Blue
OPJNUDBR	Cat 5e Slim-line UTP Jack, 568A/568B Wiring, Dual 110 / Krone IDC	Brown
OPJNUDGN	Cat 5e Slim-line UTP Jack, 568A/568B Wiring, Dual 110 / Krone IDC	Green
OPJNUDGY	Cat 5e Slim-line UTP Jack, 568A/568B Wiring, Dual 110 / Krone IDC	Gray
OPJNUDOR	Cat 5e Slim-line UTP Jack, 568A/568B Wiring, Dual 110 / Krone IDC	Orange
OPJNUDOW	Cat 5e Slim-line UTP Jack, 568A/568B Wiring, Dual 110 / Krone IDC	Off White
OPJNUDPU	Cat 5e Slim-line UTP Jack, 568A/568B Wiring, Dual 110 / Krone IDC	Purple
OPJNUDRD	Cat 5e Slim-line UTP Jack, 568A/568B Wiring, Dual 110 / Krone IDC	Red
OPJNUDWH	Cat 5e Slim-line UTP Jack, 568A/568B Wiring, Dual 110 / Krone IDC	White
OPJNUDYL	Cat 5e Slim-line UTP Jack, 568A/568B Wiring, Dual 110 / Krone IDC	Yellow

Keystone RJ11 Voice Jacks

Cat. No.	Description	Color
OPJ6CVBK	6 Wire RJ11/RJ12 Voice Jack	Black
OPJ6CVIV	6 Wire RJ11/RJ12 Voice Jack	Ivory
OPJ6CVOW	6 Wire RJ11/RJ12 Voice Jack	Off White
OPJ6CVWH	6 Wire RJ11/RJ12 Voice Jack	White



Steel City®

Concealed Service Floor Boxes

Steel City®

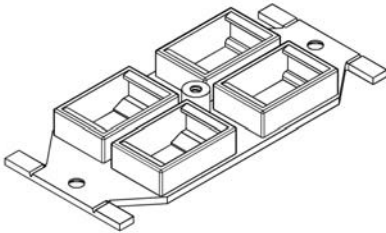

Features & Benefits

- Can be used in place of a standard duplex receptacle to mount data jacks in an outlet box, floor box, or surface raceway.
- Accepts universal "Keystone" jacks and adapters for maximum flexibility.

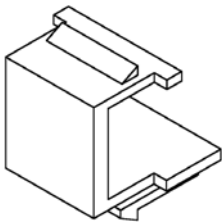
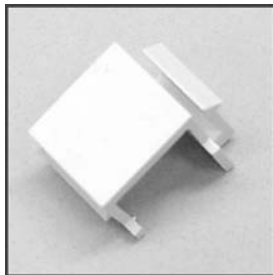

Features & Benefits

- Universal "Keystone" mounting configuration.
- Fills unused ports for an aesthetic installation.
- Available in 3 colors (shown above).

Communication Accessories

4-Port "106" Duplex Adapter

Cat. No.	Description	Color
OPOD4WH	4-Port "106" Duplex Data Adapter for Keystone Jacks	White
OPOD4OW	4-Port "106" Duplex Data Adapter for Keystone Jacks	Off White
OPOD4IV	4-Port "106" Duplex Data Adapter for Keystone Jacks	Ivory

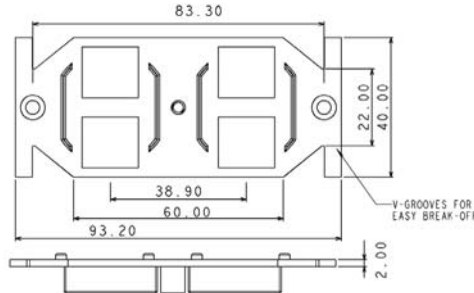

Keystone Blank Port Filler for "106" Duplex Adapter

Cat. No.	Description	Color
OPABWH	Blank Port Filler	White
OPABOW	Blank Port Filler	Off White
OPABIV	Blank Port Filler	Ivory

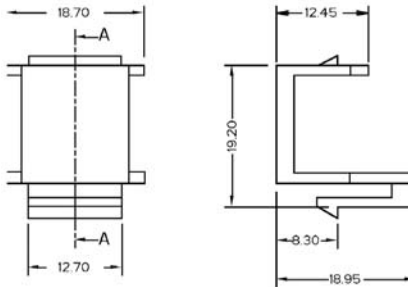

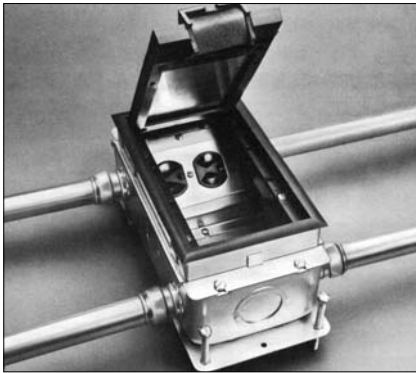

Multiple Service Floor Boxes for Power, Communications and Data

Multiple Service floor boxes that deliver power, communications and data from standard conduit with no exposed service fittings. Result: Open office planning flexibility. Ideal for the modern office with workstations that have power, communications and data equipment. Power receptacles and low voltage connections can be enclosed underfloor in either steel or cast iron bodies. Galvanized 14-gauge steel boxes are provided with knockouts from 3/4" to 1 1/4" (See Engineering Data). Cast iron bodies have threaded openings for 3/4" and 1" conduit. Hinged floor plate offers easy access to devices and is steel reinforced for superior load bearing characteristics. U.L. & CSA Listed.

Hinged Floor Plate

- Carpet covering eliminates unsightly service fittings and metal floor plates. Power cords, low voltage cables run through retractable exit.

- Power and communications/data can be disconnected quickly. Second duplex receptacle may be installed for additional power needs. Blank partitions also available.

Wide Access

- Easy to use.
- Wide 3" x 6" opening facilitates activation.

Leveling Screws

- Quick leveling to desired concrete depth.
- Box top flush with finish slab.
- After pour adjustment of floor flange: 3/4" from box top.

Engineering Data

Cat. No.	Dimensions			Before Pour Adj.	After Pour Adj.	Maximum Capacity (cu. in.)	Standard Conduit Tapping	Maximum Conduit Tapping		Conduit KO's		Covers	
	A	B	C					w/bushing	w/o bushing	Sides	Bottom	Carpet Plates	Wiring Device
664-SC	3 3/4"	4 1/16"	10 1/4"	2 1/2"	3/4"	24 per Gang 90 Total	—	—	—	(4) 1"-1 1/4" (4) 3/4"	None	664-CST Series	Duplex and/or
664-CI	3 3/4"	5 3/32"	9 15/16"	2 1/2"	3/4"	24 per Gang 90 Total	(4) 3/4" (4)-1"	1"	1 1/2"			664-CST Series	Data/Voice Plate
664-S	2 7/8"	4 1/16"	10 1/4"	1 1/2"	3/4"	16.5 per Gang 70 Total				(6) 3/4"	None	664-CST Series	Plate

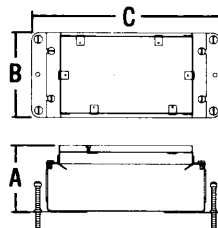

Caution: When using the center side KO's, Cat. No. 664-RP must be assembled to the box prior to installing the conduit.



664-SC

664 Series Floor Box

Cat. No.	Description	Std. Ctn.
664-SC	Stamped steel box which accepts two plates, one duplex plate provided	4
664-CI	Cast iron box which accepts two plates, one duplex plate provided	1
664-S	Shallow stamped steel box which accepts two plates, one duplex plate provided	4

Note: When ordering a 664 Series box the cover must be ordered separately.



664-S



664-CI

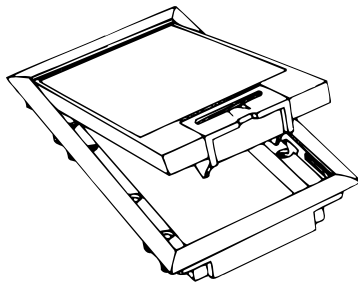

664-CST

Carpet Plate

Cat. No.	Description	Std. Ctn.
664-CST-GRY	Gray cover	1
664-CST-BRN	Brown cover	1
664-CST-BGE	Beige cover	1
664-CST-BLK	Black cover	1

Caution: When using the center side KOs, Cat. No. 664-RP must be assembled to the box prior to installing the conduit.

Load Test Data

Cat. No.	Load (lbs.)	Deflection	Notes
664CST	1000	.153	No Permanent Deflection Cover Remains Undamaged
	1250	.167	
	1500	.181	
	1750	.209	
	2000	.245	Slight Permanent Deflection Maximum Load to Failure
	2250	.290	
	2460		

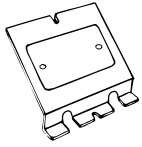

664-BP

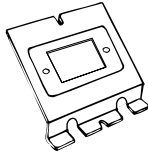

664-GP

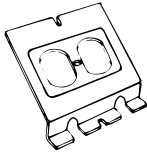

664-RP

- Duplex receptacle face plate for 664 Series floor box for additional power service.
- Does not include duplex receptacle. Can be placed at either end of floor box.

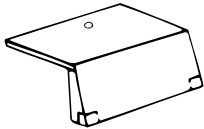

664-S-BP

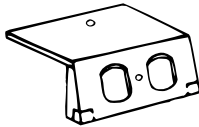

664-S-RP

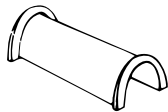

664-WT



664-S-WT

- Wire tunnel for protecting electrical connections between the two duplex receptacles when the box is used for power/power application.

Accessories

Device Plates – 664 & 664-CI

Cat. No.	Description	Std. Ctn.
664-RP	For use with 664 and 664-CI floor boxes	4
664-BP	Blank plate for use with 664 & 664-CI floor boxes	4
664-GP	GFCI receptacle plate	4

Caution: When using the center side KO's, all 664 plates must be assembled to the box prior to installing the conduit.

Device Plates – 664-S

Cat. No.	Description	Std. Ctn.
664-S-RP	For use with 664-S floor box	4
664-S-BP	Blank plate for use with 664-S floor boxes	4

Wire Tunnel

Cat. No.	Description	Std. Ctn.
664-S-WT	For use with 664-S floor box	4
664-WT	For use with 664 and 664-CI floor boxes	4

Steel City®

Concealed Service Floor Boxes

Steel City®



663-SC

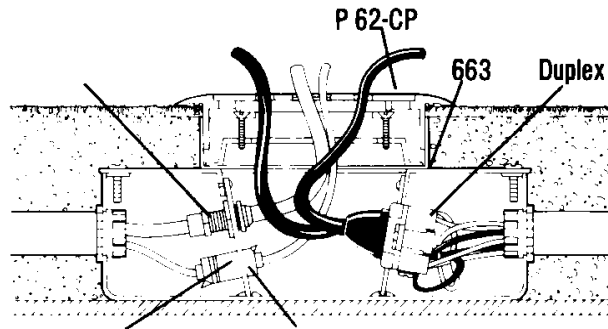

Communications Connector

- Multiple service floor box that delivers power, communications and data from standard conduit with no exposed service fittings.
- Result: Open office planning flexibility.
- Ideal for workstations that require power, communications and data service.
- Stamped steel, concrete tight, semi-adjustable.
- Electrogalvanized body and hardware.
- Shipped complete with expendable cap to prevent ingress of concrete.
- Blank and duplex face plates can be mounted at either end of the box.
- Does not include duplex faceplate; faceplate is included with P 62-CP and P 60-3B cover plates.
- Uses P 62 and P 60 Series covers*.

Caution: To abandon 663 you must use a P60 series brass cover plate.

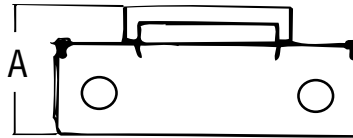
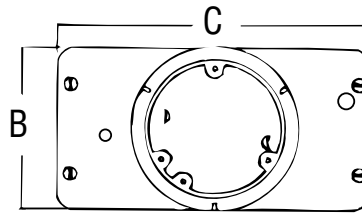

663 Series Floor Box

Cat. No.	Dimensions			Before Pour Adj.	After Pour Adj.	Maximum Capacity (cu. in.)	Conduit KO's		Covers and Carpet Plates	Wiring Device	Std. Ctn.
	A	B	C				Sides	Bottom			
663-SC	3 $\frac{5}{8}$ "	4 $\frac{1}{16}$ "	8 $\frac{13}{16}$ "	None	$\frac{3}{4}$ "	25 per Gang 90 Total	2—1-1 $\frac{1}{4}$ " 4— $\frac{3}{4}$ "	None	P-62 Series P-60 Series	Duplex and/or Data/Voice	4

* P 62-TAR is required when using P 60 series covers.

Concealed Service Floor Boxes



P-60-3B

- Polished brass finish with nonmetallic bronze insert.
- Plastic insert has one 7/8" cutout and two 1/2" cutouts.
- Furnished complete with sealing gasket, 8-32 x 1/16" brass screws and one P 60-Q device plate.
- High strength polycarbonate.
- Split cover sections have access notch for screwdriver lift.



P-62-CP

- Molded support ribs for extra strength.
- Furnished with one 7/8" cutout and two 1/2" cutouts and P 60-Q device plate.
- 5 5/8" outside diameter.
- Furnished with 3-12-24 x 1" screws.



P-60-CP

- Polished brass finish.
- Furnished complete with 8-32 x 1" brass screws.
- P 62-TAR is required when used on 663 floor box.
- 5 11/16" outside diameter.

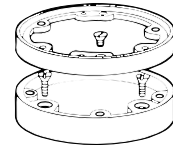

P-62-TAR

- Gives 3/4" adjustment when mounted on 663 floor box.
- Accepts P-60-3B, P-60-CP, and all P 60 Series cover plates.

Covers, Carpet Plates and Adjusting Rings for 663 Floor Box

Cat. No.	Description	Std. Ctn.
P-60-3B*1	Cover plate—includes 1 - P60Q	4
P-62-CP-AS*2	Polycarbonate cover and carpet plate (charcoal)—includes 1 - P60Q	4
P-62-CP-BRN*2	Polycarbonate cover and carpet plate (brown)—includes 1 - P60Q	4
P-62-CP-G*2	Polycarbonate cover and carpet plate (gold)—includes 1 - P60Q	4
P-60-CP	Carpet plate (polished brass)	4
P-60-CP-AL	Carpet plate (aluminum)	4
P-62-TAR	Flange and adjusting ring for 663 box (brass)	4
P-62-TAR-AL	Flange and adjusting ring for 663 box (aluminum)	4

* For use as cover only when box is in service.

1 When not in use replace P603B Grommet with 697 Plug.

2 When not in use the P62CP Series Cover should be replaced by P60CP, P60, and P62 TAR Series Covers.

† **Caution:** These covers are not to be used in high traffic areas.

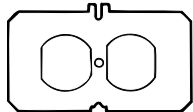

P-60-Q

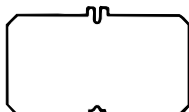

P-60-QB

Face Plates for 663 Floor Box

Cat. No.	Description	Std. Ctn.
P-60-Q	Duplex receptacle plate for 663 floor box	4
P-60-QB	Blank plate for 663 floor box	4



68-D



600

Floor Boxes for Single and Duplex Receptacles, or Communications and Data

68 and 600 Series Floor Boxes provide flush service for power or communications / data. 68 and 600 Series Floor Boxes can be used for carpet or tile applications and provide the features listed below.

Features – 68 Series

- Stamped steel, concrete tight, fully adjustable.
- Electrogalvanized body and hardware.
- Interior and exterior leveling screws permit adjustment to meet finished floor.
- Shipped complete with expendable cap to prevent ingress of concrete during pour ½", ¾" and 1" knockouts – all bottom knockouts are accessible.
- Uses P60 Series mop tight covers and carpet plate.

- For brushed aluminum, add AL after catalog number.

Features – 600 Series

- Cast iron, watertight body, fully adjustable.
- Painted silver enamel inside and out for additional corrosion resistance.
- Interior and exterior leveling screws permit adjustment to meet finished floor.
- Shipped complete with expendable cap to prevent ingress of concrete during pour.
- ¾" threaded conduit openings are standard.
- Uses P60 Series mop tight covers and carpet plate.
- For brushed aluminum, add AL after catalog number.

Engineering Data

Cat. No.	Dimensions			Before Pour Adj.	After Pour Adj.	Maximum Capacity (cu. in.)	Standard Conduit Tapping	Maximum Conduit		KO's Sides	Bottom
	A	B	C					Tapping w bushing	Conduit w/o bushing		
68-D	4¼"	3⅞"	4⅞"	2½"	½"	60	–	–	–	(4) ¾" (4) 1" (8) ½"	(3) ½" (2) ¾" (3) ½"
68-S	4¼"	2¾"	4⅞"	1½"	½"	47	–	–	–	(4) ¾"	(2) ¾"
600-SC	4¼"	4¼"	5⅞"	2½"	1⅝"	64	¾"	1½"	2"	–	–
600-1	4¼"	4¼"	5⅞"	2½"	1⅝"	64	1"	1"	1"	–	–
600-1-1/4	4¼"	4¼"	5⅞"	2½"	1⅝"	64	1¼"	1¼"	1¼"	–	–
600-2	4¼"	4¼"	5⅞"	2½"	1⅝"	64	2"	1½"	2"	–	–
601-SC	4¼"	3"	5⅞"	2½"	1⅝"	56	¾"	1"	1¼"	–	–
601-1	4¼"	3⅞"	5⅞"	2½"	1⅝"	56	1"	1"	1"	–	–
601-1-1/4	4¼"	3⅞"	5⅞"	2½"	1⅝"	56	1¼"	1¼"	1¼"	–	–
602-SC	4¼"	3½"	4"	2½"	1⅝"	36	¾"	¾"	1"	–	–
603-SC	4¼"	2½"	4"	2½"	1⅞"	27	¾"	¾"	¾"	–	–
604-SC	4¼"	2"	4"	1½"	–	15	¾"	¾"	¾"	–	–

Use P60 Series Covers and Carpet Plates
Wiring Device: Duplex, Single or Voice/Data Plates

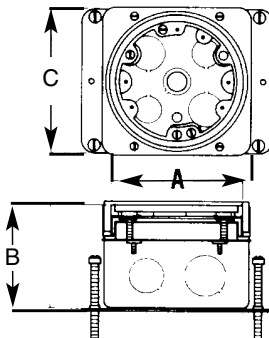



68-D



600



601



602



603



604

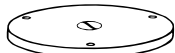

P-60-1/2

1/2" N.P.S. Plug Size

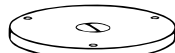

P-60-3/4

3/4" N.P.S. Plug Size



P-60-1

1" N.P.S. Plug Size



P-60-1-1/4

1 1/4" N.P.S. Plug Size



P-60-2*

2" Dia. Plug Size



P-60-2-5/8*

2 5/8" Dia. Plug Size



P-60-1/2-2*

1/2" & 2" Dia. Plug Size



P-60-3/4-2*

3/4" & 2" Dia. Plug Size



P-60-DU*
Duplex
1 1/16" Plugs



P-60-DR*
Duplex Lift Lid

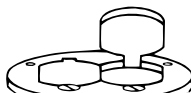

P-60-DS*
Hinged Lift Lids



P-60-GFCI*

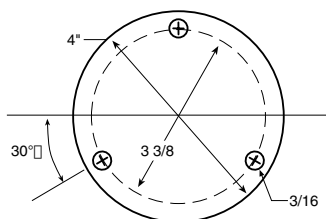

* Also includes steel seating plate for receptacles.

68 and 600 Series Floor Boxes

Cat. No.	Description	Std. Ctn.
68-D	Stamped steel floor box	4
68-D-AL	Stamped steel with aluminum trim ring	4
68-S	Stamped steel shallow box	4
68-S-AL	Shallow with aluminum trim ring	4
600-SC	Cast iron floor box 3/4" conduit tapping	4
600-AL-SC	Cast iron floor box with aluminum trim ring	4
600-1-SC	Cast iron floor box 1" conduit tapping	4
600-2-SC	Cast iron floor box 2" conduit tapping	4
601-1/2-SC	Cast iron floor box 1/2" conduit tapping	4
601-AL-SC	Cast iron floor box 3/4" conduit tapping with aluminum trim ring	4
601-SC	Cast iron floor box 3/4" conduit tapping	4
601-1	Cast iron floor box 1" tapping	4
601-1-1/4	Cast iron floor box 1 1/4" conduit tapping	4
602-SC	Cast iron floor box 3/4" conduit tapping	4
602-AL-SC	Cast iron floor box 3/4" conduit tapping with aluminum trim ring	4
602-1	Cast iron floor box 1" conduit tapping	4
603-SC	Cast iron floor box 3/4" conduit tapping	4
603-AL-SC	Cast iron floor box 3/4" conduit tapping with aluminum trim ring	4
604-SC	Cast iron floor box 3/4" conduit tapping	4
604-AL-SC	Cast iron floor box 3/4" conduit tapping with aluminum trim ring	4

P60 Covers sold separately.



Carpet and Mop Tight Cover Plates for 68 and 600 Series Floor Boxes

Cat. No.	Description	Std. Ctn.
P-60-1/2	Brass cover plate 1/2" NPS plug size	4
P-60-1/2-AL	Aluminum cover plate 1/2" NPS plug size	4
P-60-3/4	Brass cover plate 3/4" NPS plug size	4
P-60-3/4-AL	Aluminum cover plate 3/4" NPS plug size	4
P-60-1	Brass cover plate 1" NPS plug size	4
P-60-1-AL	Aluminum cover plate 1" NPS plug size	4
P-60-1-1/4	Brass cover plate 1 1/4" NPS plug size	4
P-60-1-1/4-AL	Aluminum cover plate 1 1/4" NPS plug size	4
P-60-2	Brass cover plate 2" diameter plug size	4
P-60-2-AL	Aluminum cover plate 2" diameter plug size	4
P-60-2-5/8	Brass cover plate 2 5/8" diameter plug size	4
P-60-2-5/8-AL	Aluminum cover plate 2 5/8" diameter plug size	4
P-60-1/2-2	Brass cover plate 1/2"-2" diameter plug size	4
P-60-1/2-2-AL	Aluminum cover plate 1/2"-2" diameter plug size	4
P-60-3/4-2	Brass cover plate 3/4"-2" diameter plug size	4
P-60-3/4-2-AL	Aluminum cover plate 3/4"-2" diameter plug size	4
P-60-DR	Brass cover with duplex lift lid	4
P-60-DR-AL	Aluminum cover with duplex lift lid	4
P-60-DS	Brass cover for duplex with individual lift lids	4
P-60-DS-AL	Aluminum cover for duplex with individual lift lids	4
P-60-DU	Brass cover plate with 2-1 1/16" plugs for duplex	4
P-60-DU-AL	Aluminum cover with 2-1 1/16" plugs for duplex	4
P-60-GFCI	Brass cover plate for GFCI devices	4

AL suffix indicates brushed aluminum finish

- Polished finish.
- Furnished complete with sealing gasket and 8-32 x 1/16" brass screws.
- 4" outside diameter.
- For brushed aluminum, add AL after catalog number.

Steel City®

Flush Service Floor Boxes

Steel City®



P-60-CP

- Polished brass finish.
- Furnished complete with 8-32 x 1" brass screws.
- For brushed aluminum, add AL after catalog number.



P-60-LCP

- Translucent Polycarbonate.
- Textured finish.

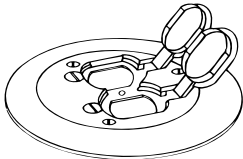

P-60-CACP

- Polished brass finish.
- Integrated carpet plate duplex floor plate in one unit.
- Furnished complete with sealing gasket and 8-32 x 1" brass screws.
- 5 3/4" outside diameter.

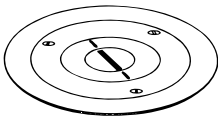

P-60-3/4-2-CACP

- Polished brass finish.
- Integrated carpet plate/3/4"-2" Floor Plate in one unit.
- Furnished complete with sealing gasket and 8-32 x 1" brass screws.
- 5 3/4" outside diameter.

Carpet Plates for 68 and 600 Series Floor Boxes

Cat. No.	Description	Std. Ctn.
P-60-CP	Brass carpet plate, 5 1/16" diameter	4
P-60-CPAL	Aluminum carpet plate	4
P-60-LCP	Polycarbonate carpet plate, 5 3/8" diameter	4
P-60-CACP	Brass one piece carpet cover plate	4
P-60-CACP-AL	Aluminum one piece carpet	4
P-60-3/4-2-CACP	Brass one piece carpet plate with 3/4"-2" plugs	4
P60-CACP-GFCI	Brass one-piece carpet plate for GFCI devices	4

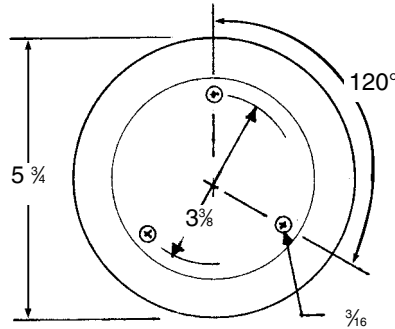

P-60-CACP

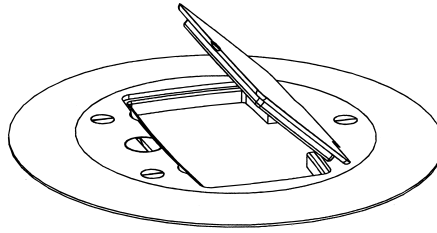

P-60-CACP-GFCI



78SC



88-D



98

Floor Boxes for Single Short Strap Receptacles or Communications and Data

Service Fitting Application

78, 88 and 98 Series Floor Boxes provide flush service for power or communications and data. 78, 88 and 98 Series Floor Boxes can be used for either carpet or tile applications and provide the features listed below.

Features – 78 Series

- Cast iron, watertight body, semi-adjustable.
- Painted silver enamel inside and out for additional corrosion resistance.
- Exterior leveling screws and threaded vertical adjusting ring permit adjustment to meet finish floor.
- Shipped complete with expandable cap to prevent ingress of concrete during pour.
- ¾" threaded conduit openings.
- Uses P90 Series mop tight covers.

Features – 88 Series

- Stamped steel, concrete tight, semi-adjustable.
- Electrogalvanized body and hardware.

- Exterior leveling screws and threaded vertical adjusting ring permit adjustment to meet finish floor.
- Shipped complete with expandable cap to prevent ingress of concrete during pour.
- ½" and ¾" knockouts—all bottom knockouts accessible.
- Uses P90 Series mop tight covers.

Features – 98 Series

- Stamped steel, concrete tight, semi-adjustable.
- Electrogalvanized body and hardware.
- 2⅞" deep box body—extra capacity for junction box use.
- Shipped complete with expandable cap to prevent ingress of concrete during pour.
- ½" through 1¼" knockouts for maximum utility.
- Uses P90 Series mop tight covers.

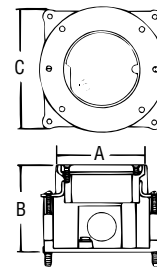
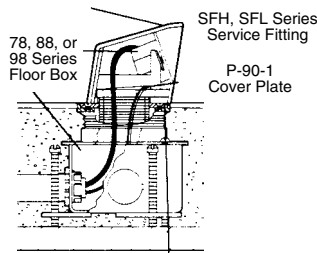

Engineering Data for 78, 88 and 98 Series Floor Boxes

Cat. No.	Dimensions			Before Pour Adj.	After Pour Adj.	Maximum Capacity (cu. in.)	Standard Conduit Tapping	Maximum Conduit Tapping		Conduit KO's		Covers and Carpet Plates	Wiring Device
	A	B	C					w bushing	w/o bushing	Sides	Bottom		
78SC	3"	2 ¹³ / ₁₆ "	3 ⁷ / ₈ "	2½"	¾"	24	¾"	¾"	1"	—	—	P90 Series	Sing. Short Strap Rec.
78-S	3"	2 ⁵ / ₈ "	3 ⁷ / ₈ "	1½"	¾"	20	¾"	¾"	1"	—	—	P90 Series	Sing. Short Strap Rec.
88-D	3"	3¼"	5¾"	2½"	¾"	29	—	—	—	(2) ½"	(3) ½"	P90 Series	Sing. Short Strap Rec.
88-DA	3"	3¼"	5¾"	2½"	¾"	29	—	—	—	(2) ¾"	(2) ¾"	P90 Series	Sing. Short Strap Rec.
88-S	3"	2¾"	5¾"	1½"	¾"	23	—	—	—	(4) 1"	(2) ¾"	P90 Series	Sing. Short Strap Rec.
98	3"	3⅝"	4 ¹ / ₁₆ "	—	¾"	46	—	—	—	(2) ½"	(3) ½"	P90 Series	Sing. Short Strap Rec.
										Two Each	(2) ½"	P90 Series	Sing. Short Strap Rec.
										½, ¾	(1) ¾"		
										1", 1¼"	(1) 1¼"		

Steel City®

Flush Service Floor Boxes



Steel City®



78SC



88-D



98

Series 78, 88 and 98 Floor Boxes

Cat. No.	Description	Std. Ctn.
78SC	Cast iron single gang floor box with 3/4" conduit tapping	4
78-S	Cast iron single gang floor box (shallow)	4
88-D	Stamped steel single gang floor box with 1/2" and 3/4" conduit tapping	4
88-S	Shallow version stamped steel	4
98	Stamped steel single gang floor box with 1/2", 3/4", 1", 1 1/4" conduit tapping	4

Cover Plates for 78, 88 and 98 Series Floor Boxes

Cat. No.	Description	Std. Ctn.
P-90-1/2	Cover plate 1/2" NPS plug (brass)	4
P-90-1/2-AL	Cover plate 1/2" NPS plug (aluminum)	4
P-90-3/4	Cover plate 3/4" NPS plug (brass)	4
P-90-3/4-AL	Cover plate 3/4" NPS plug (aluminum)	4
P-90-1	Cover plate 1" NPS plug (brass)	4
P-90-1-AL	Cover plate 1" NPS plug (aluminum)	4
P-90-1-1/4	Cover plate 1 1/4" NPS plug (brass)	4
P-90-1-1/4-AL	Cover plate 1 1/4" NPS plug (aluminum)	4
P-90-2	Cover plate 2" UN plug (brass)	4
P-90-2-AL	Cover plate 2" UN plug (aluminum)	4
P-90-1/2-2	Cover plate 1/2" & 2" plug (brass)	4
P-90-1/2-2-AL	Cover plate 1/2" & 2" plug (aluminum)	4
P-90-3/4-2	Cover plate 3/4" & 2" plug (brass)	4
P-90-3/4-2-AL	Cover plate 3/4" & 2" plug (aluminum)	4

* Also includes steel seating plates for receptacles.



P-90-1/2
1/2" N.P.S. Plug



P-903/4
3/4" N.P.S. Plug



P-90-1
1" N.P.S. Plug

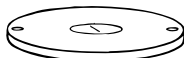

P-90-1-1/4
1 1/4" N.P.S. Plug



P-90-2*
2" Dia. Plug



P-90-1/2-2*
1/2" & 2" Dia. Plugs



P-90-3/4-2*
3/4" & 2" Dia. Plugs

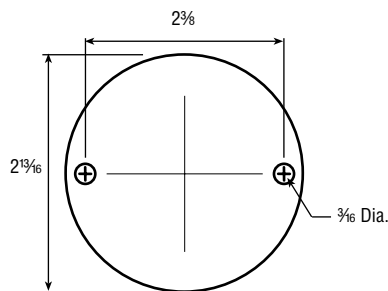

- Polished brass finish.
- Furnished complete with sealing gasket and 6-32 x 1/2" brass screws.
- 2 3/8" outside diameter.
- For brushed aluminum, add AL after catalog number.

Thomas & Betts

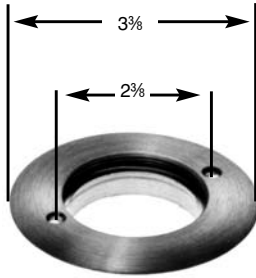

P-90-CP

- Polished brass finish.
- Furnished complete with 6-32x1" brass flathead screws and gasket.
- Threaded 2-20UN-2B, to accept 694 plug.
- 3" O.D. with 3/8" flange.
- For brushed aluminum add AL after catalog number.



8805-E

- Extends vertical adjusting ring 1 1/8".
- Seven cubic inch capacity.



478-G-12

- 15 Amp, 125 Volt, NEMA grounding type.
- Mounted on steel seating plate.
- For use with 2" diameter opening floor plate.

Carpet Plate for 78, 88 and 98 Series Floor Boxes

Cat. No.	Description	Std. Ctn.
P-90-CP	Carpet plate (brass)	4
P-90-CP-AL	Carpet plate (aluminum)	4

Note: Will not accept P90 Covers.

Note: Will accept 694 threaded plug.

Accessories for 78, 88 and 98 Series Floor Boxes

Cat. No.	Description	Std. Ctn.
8805-E	Extension adjusting ring	4
478-G-12	15 AMP 125 volt NEMA grounding receptacle	4

Steel City®

Flush Service Floor Boxes

Steel City®

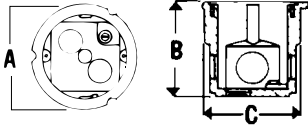

Floor Boxes for Single Short Strap Receptacles or Communications and Data

671 and 672 Series Floor Boxes provide flush service for power or communications and data. 671 and 672 Series floor boxes can be used in either wood

or concrete floors and are suitable for carpet, tile or wood applications. They provide the features listed below.



671SC

- Cast iron, watertight, non-adjustable.
- Painted silver enamel inside and out for additional corrosion resistance.
- For use in wood or concrete floors.
- 1/2" and 3/4" threaded conduit openings; uses P67 Series covers.



672

- Catalog No. 672 is the 671 floor box with factory-mounted 15 ampere, 125 volt, NEMA grounding receptacle and P67-2 cover plate.



Cat. No.	Dimensions			Maximum Capacity (cu. in.)	Standard Conduit Tapping	Maximum Conduit Tapping		Conduit KO's		Covers/ Carpet Plates	Wiring Device	Std. Ctn.
	A	B	C			w/bushing	w/o bushing	Sides	Bottom			
671SC	3 1/2"	3"	2 3/32"	13	2—3/4"	3/4"	3/4"	2—1/2"	2—1/2"	P67 Series	Sing. Short Strap Rec.	4
672	3 1/2"	3 3/16"	2 3/32"	13	4—1/2"	3/4"	3/4"	2—1/2"	2—1/2"	P67 Series	Sing. Short Strap Rec.	4

* Note: 672-AL is available as a special ("SP"); consult factory.



P-67-1/2
1/2" N.P.S. plug



P-67-3/4
3/4" N.P.S. plug



P-67-1
1" N.P.S. plug



P-67-1-1/4*
1 1/4" N.P.S. plug



P-67-2
2" Dia. plug



P-67-1/2-2*
1/2" & 2" Dia. plugs

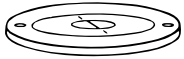

P-67-3/4-2*
3/4" & 2" Dia. plugs

* Also includes seating plate for receptacle.

- Polished brass finish.
- Furnished complete with sealing gasket and 6-32 x 1/2" brass screws.
- 3 1/2" outside diameter.

Cover Plates for 671 and 672 Floor Boxes

Cat. No.	Description	Std. Ctn.
P-67-1/2	Cover plate with 1/2" NPS plug (brass)	4
P-67-3/4	Cover plate with 3/4" NPS plug (brass)	4
P-67-3/4-AL	Cover plate with 3/4" NPS plug (aluminum)	4
P-67-1	Cover plate with 1" NPS plug (brass)	4
P-67-1-AL	Cover plate with 1" NPS plug (aluminum)	4
P-67-1-1/4	Cover plate with 1 1/4" NPS plug (brass)	4
P-67-2	Cover plate with 2" UN thread plug (brass)	4
P-67-2-AL	Cover plate with 2" UN thread plug (aluminum)	4
P-67-1/2-2	Cover plate with 1/2" & 2" plug (brass)	4
P-67-3/4-2	Cover plate with 3/4" & 2" plug (brass)	4

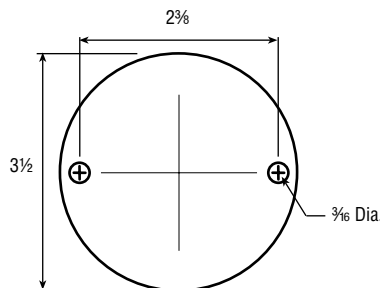

Thomas & Betts



P-90-CP

- Polished brass finish.
- Furnished complete with 6-32 x 1" long brass flathead screws and gasket.
- For brushed aluminum add AL after catalog number.
- 3 3/4" outside diameter.



P-67-F
Edge Ring

Use brass edge ring for neat appearance when non-adjustable floor box is installed in concrete. Edge ring has 3 3/4" OD and adds 3/8" to floor box height.



478-G-12
Short Strap Receptacle

- 15 amp, 125 volt, NEMA grounding type.
- Mounted on steel seating plate.
- For use with 2" diameter opening floor plate.

Carpet Plates for 671 and 672 Floor Boxes

Cat. No.	Description	Std. Ctn.
P-90-CP	Carpet plate (brass)	4
P-90-CP-AL	Carpet plate (aluminum)	4

Note: Will not accept P90 covers.

Note: Will accept 694 threaded plug page D34.

Accessories for 671 and 672 Floor Boxes

Cat. No.	Description	Std. Ctn.
P-67-F	Brass edge ring for concrete	4
478-G-12	15 amp, 125 V NEMA grounding receptacle	4

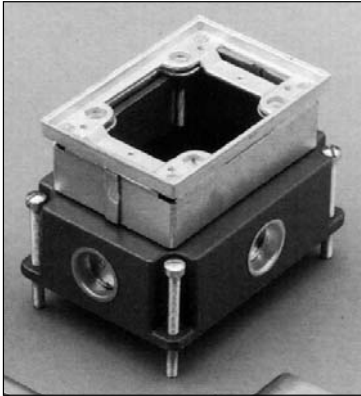

641

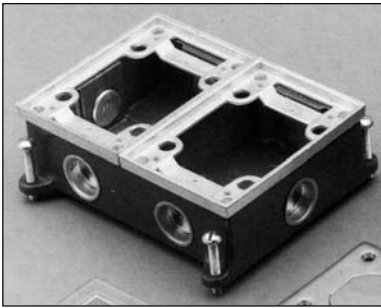

842SC

Multiple Gang Floor Boxes for Single and Duplex Receptacles, Communications and Data

640 and 840 Series Floor Boxes provide flush service for power, communications and data. Multiple gang boxes allow the user to place high and low voltage in a single floor box. Floor boxes up to four gangs are available. 640 and 840 Series boxes can be used for either carpet or tile applications and provide the features listed below.

Features – 640 Series

- Cast iron, watertight body, fully adjustable.
- Painted silver enamel inside and out for additional corrosion resistance.
- Interior and exterior leveling screws permit adjustment to finished floor.
- Removable partitions for large capacity requirements on 2, 3, and 4 gang.
- Shipped complete with expendable cap to prevent ingress of concrete during pour.
- 3/4" threaded conduit openings are standard.

- Uses P64 Series mop tight covers (one cover per gang).
- For brushed aluminum, add AL after catalog number.

Features – 840SC Series (Shallow Type)

- Cast iron, watertight body, semi-adjustable.
- Painted silver enamel inside and out for additional corrosion resistance.
- Exterior leveling screws for adjustment to finished floor.
- Removable partitions for large capacity requirements on 2 and 3 gang.
- Shipped complete with expendable cap to prevent ingress of concrete during pour.
- 3/4" threaded conduit openings are standard.
- Uses P64 Series mop tight covers (one cover per gang).
- For brushed aluminum, add -AL after catalog number.

Engineering Data

Cat. No.	Dimensions			Before Pour Adj.	After Pour Adj.	Number of Gangs	Maximum Capacity (cu. in.)	Standard Conduit Tapping	Maximum Conduit Tapping	
	A	B	C						w/bushing	w/o bushing
641	3 5/8"	4"	5 1/2"	2 1/2"	5/8"	1	35	3/4"	1"	1 1/4"
642	3 5/8"	7"	5 1/2"	2 1/2"	5/8"	2	37 Per Gang	3/4"	1"	1 1/4"
643	3 5/8"	10"	5 1/2"	2 1/2"	5/8"	3	37 Per Gang	3/4"	1"	1 1/4"
644	4 1/2"	12 15/16"	5 1/2"	2 1/2"	5/8"	4	37 Per Gang	3/4"	1"	1 1/4"
841SC	2"	4"	5 1/2"	1 1/2"	—	1	15	3/4"	3/4"	3/4"
842SC	2"	7"	5 1/2"	1 1/2"	—	2	16.5 Per Gang	3/4"	3/4"	3/4"
843SC	2"	10"	5 1/2"	1 1/2"	—	3	16.5 Per Gang	3/4"	3/4"	3/4"

Use P64 Series Covers and Carpet Plates
Wiring Device: Duplex, single or voice/data plates.

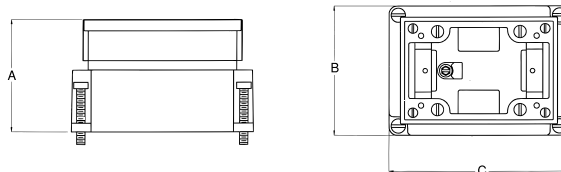

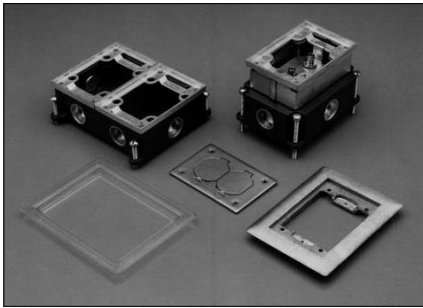

Series 640 and 840SC Floor Boxes

Cat. No.	Description	Std. Ctn.
641	Cast iron single gang floor box with 3/4" conduit tapping	4
641-1	Cast iron single gang floor box with 1" conduit tapping	4
641-AL	Cast iron single gang with aluminum trim	4
SP-641-1-AL	Cast iron single gang floor box with 1" conduit tapping and aluminum tile trim	4
642	Cast iron two gang floor box with 3/4" conduit tapping	2
642-1	Cast iron two gang floor box with 1" conduit tapping	2
642-AL	Cast iron two gang floor box with aluminum trim	2
SP-642-1-AL	Cast iron two gang floor box with 1" conduit tapping and aluminum tile trim	2
643	Cast iron three gang floor box with 3/4" conduit tapping	1
SP-643-1	Cast iron three gang floor box with 1" conduit tapping	1
643-AL	Cast iron three gang floor box with aluminum trim	1
SP-643-1-AL	Cast iron three gang floor box with 1" conduit tapping and aluminum tile trim	1
644	Cast iron four gang floor box with 3/4" conduit tapping	1
644-AL	Cast iron four gang floor box with aluminum trim	1
841-SC	Cast iron single gang floor box (shallow design) with 3/4" conduit tapping	4
841-AL	Cast iron single gang floor box (shallow design) with aluminum trim	4
842-SC	Cast iron two gang floor box (shallow design) with 3/4" conduit tapping	2
842-AL-SC	Cast iron two gang floor box (shallow design) with aluminum trim	2
843-SC	Cast iron three gang floor box (shallow design) with 3/4" conduit tapping	1
843-AL-SC	Cast iron three gang floor box (shallow design) with aluminum trim	1

Boxes supplied with brass tile trim unless otherwise specified.

Metallic Cover Plates for 840 and 640 Series

Cat. No.	Description	Std. Ctn.
P-64-1/2	Cover plate 1/2" NPS plug (brass)	4
P-64-1/2-AL	Cover plate 1/2" NPS plug (aluminum)	4
P-64-3/4	Cover plate 3/4" NPS plug (brass)	4
P-64-3/4-AL	Cover plate 3/4" NPS plug (aluminum)	4
P-64-1	Cover plate 1" NPS plug (brass)	4
P-64-1-AL	Cover plate 1" NPS plug (aluminum)	4
P-64-1-1/4	Cover plate 1 1/4" NPS plug (brass)	4
P-64-1-1/4-AL	Cover plate 1 1/4" NPS plug (aluminum)	4
P-64-2	Cover plate 2" UN plug (brass)	4
P-64-2-AL	Cover plate 2" UN plug (aluminum)	4
P-64-1/2-2	Cover plate 1/2" & 2" UN plug (brass)	4
P-64-1/2-2-AL	Cover plate 1/2" & 2" UN plug (aluminum)	4
P-64-3/4-2	Cover plate 3/4" & 2" UN plug (brass)	4
P-64-3/4-2-AL	Cover plate 3/4" & 2" UN plug (aluminum)	4
P-64-2-5/8	Cover plate 2 5/8" UN plug (brass)	4
P-64-2-5/8-AL	Cover plate 2 5/8" UN plug (aluminum)	4
P-64-DU	Cover plate duplex 1 7/16" plugs (brass)	4
P-64-DU-AL	Cover plate duplex 1 7/16" plugs (aluminum)	4
P-64-DS	Cover plate duplex lift lids (brass)	4
P-64-DS-AL	Cover plate duplex lift lids (aluminum)	4
P-64-GFCI	Cover plate GFCI flip lid (brass)	4

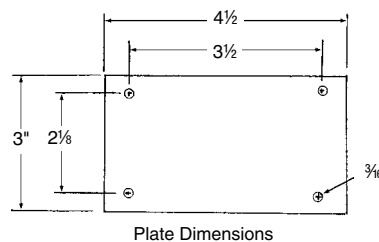
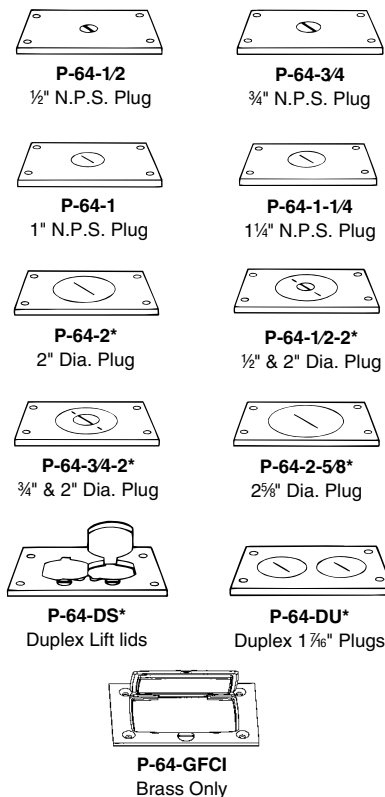

*Also includes seating plate for receptacle like others.

- Polished brass finish.
- Furnished complete with sealing gasket and 8-32 x 7/16" brass screws.
- 3" x 4 1/2" outside dimension.
- For brushed aluminum, add AL after catalog number.
- All covers meet mop tight requirements.

Steel City®

Flush Service Floor Boxes

Steel City®

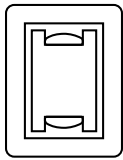

P64-CP

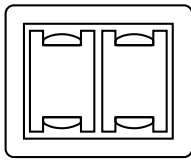

P64-2G-CP

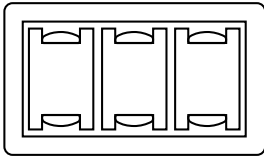

P64-3G-CP

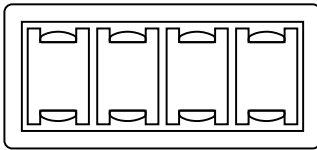

P64-4G-CP

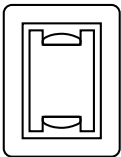

P64P-CP

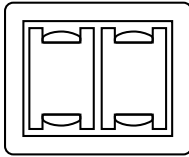

P64P-2G-CP

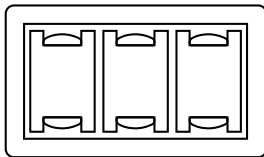

P64P-3G-CP

- Translucent polycarbonate material.
- Textured finish.
- To install LCP Series Plates remove trim ring and place inside. Replace trim ring on box.



P64P-URC

Metallic Carpet Plates for 640 and 840 Series

Cat. No.	Number of Gangs	Outside Dimension	Material	Std. Ctn.
P64-CP	1	4 $\frac{5}{8}$ " x 6 $\frac{1}{8}$ "	Brass	4
P64-CP-AL	1	4 $\frac{5}{8}$ " x 6 $\frac{1}{8}$ "	Aluminum	4
P64-2G-CP	2	7 $\frac{5}{8}$ " x 6 $\frac{1}{8}$ "	Brass	4
P64-2G-CP-AL	2	7 $\frac{5}{8}$ " x 6 $\frac{1}{8}$ "	Aluminum	4
P64-3G-CP	3	10 $\frac{5}{8}$ " x 6 $\frac{1}{8}$ "	Brass	4
P64-3G-CP-AL	3	10 $\frac{5}{8}$ " x 6 $\frac{1}{8}$ "	Aluminum	4
P64-4G-CP	4	13 $\frac{5}{8}$ " x 6 $\frac{1}{8}$ "	Brass	4
P64-4G-CP-AL	4	13 $\frac{5}{8}$ " x 6 $\frac{1}{8}$ "	Aluminum	4

Nonmetallic Carpet Plates for 640 and 840 Series

Cat. No.	Number of Gangs	Description	Finish	Std. Ctn.
P64P-CP-BLK	1	Single Gang Carpet Plate	Black	4
P64P-CP-GRY	1	Single Gang Carpet Plate	Gray	4
P64P-CP-BGE	1	Single Gang Carpet Plate	Beige	4
P64P-2G-CP-BLK	2	Two Gang Carpet Plate	Black	4
P64P-2G-CP-GRY	2	Two Gang Carpet Plate	Gray	4
P64P-2G-CP-BGE	2	Two Gang Carpet Plate	Beige	4
P64P-3G-CP-BLK	3	Three Gang Carpet Plate	Black	4
P64P-3G-CP-GRY	3	Three Gang Carpet Plate	Gray	4
P64P-3G-CP-BGE	3	Three Gang Carpet Plate	Beige	4
P64P-LCP	1	Single Gang Carpet Plate	Clear	4
P64P-2LCP	2	Two Gang Carpet Plate	Clear	4
P64P-3LCP	3	Three Gang Carpet Plate	Clear	4



P64-LCP

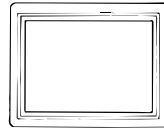

P64-2LCP



P64-3LCP

Nonmetallic Cover Plates for 640 and 840 Series

Cat. No.	Description	Color	Std. Ctn.
P64P-URC-BLK	Universal Cover	Black	4
P64P-URC-GRY	Universal Cover	Gray	4
P64P-URC-BGE	Universal Cover	Beige	4
P64P-BP-BLK	Blank Cover	Black	4
P64P-BP-GRY	Blank Cover	Gray	4
P64P-BP-BGE	Blank Cover	Beige	4

Thomas & Betts

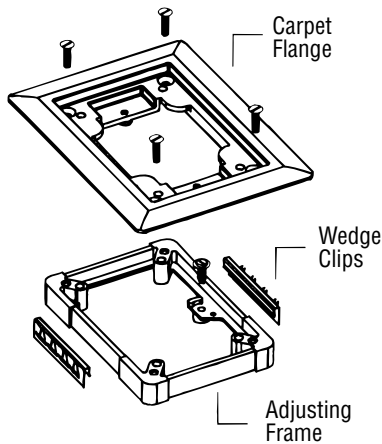
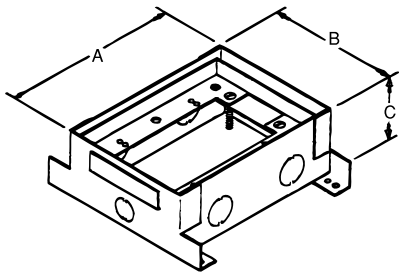
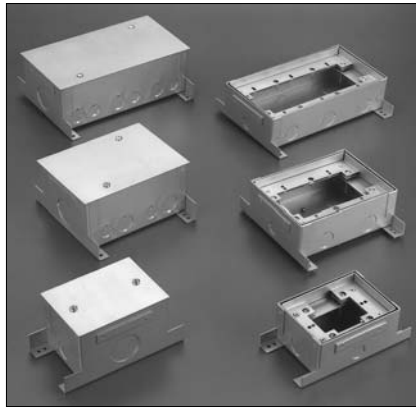

Carpet Activation Kit

Steel City® 740 Series Steel Floor Boxes



The new 740 series line of stamped steel floor boxes are an extension of T&B's industry leading 640 and 840 series cast iron floor boxes. The new boxes provide flush service for power, communications and data. Multiple-gang boxes allow the user to place high and low voltage in a single floor box. The 740 series can be used for carpet or tile applications.

Features

- Available in shallow (2 $\frac{5}{8}$ ") and deep (3 $\frac{5}{8}$ ") versions.
- U.L. listed and CSA certified.
- Available in one, two, and three-gang versions.
- Two and three-gang boxes are supplied with customer installed dividers.

- 16 ga. pre-galvanized steel construction.
- Adjustable with four exterior leveling legs capable of 2" pre-pour adjustment and an interior leveling ring capable of 1/4" after-pour adjustment.
- Made with a variety of k.o.'s ranging from 1/8" to 1/4".
- Boxes utilize the 640P series metallic and nonmetallic floor box accessories with the unique one-step installation method.
- Shipped with expendable steel cap to prevent ingress of concrete at installation.

Ordering Information

Cat. No.	Description	Std. Ctn.
741-S	Shallow one-gang steel floor box for concrete construction	4
742-S	Shallow two-gang steel floor box for concrete construction	1
743-S	Shallow three-gang steel floor box for concrete construction	1
741-D	Deep one-gang steel floor box for concrete construction	4
742-D	Deep two-gang steel floor box for concrete construction	1
743-D	Deep three-gang steel floor box for concrete construction	1

Engineering Data

Cat. No.	A	B	C	Adjustment Before Pour	After Pour	Capacity Per Gang	Conduit KOs		
							Sides	Ends	Bottom
741-S	4"	5 $\frac{1}{2}$ "	2 $\frac{5}{8}$ "	2"	1 $\frac{1}{2}$ "	29 cu. in.	(2) $\frac{3}{4}$ "	(2) $\frac{1}{2}$ "	(1) $\frac{1}{2}$ " & (1) $\frac{3}{4}$ "
742-S	7 $\frac{1}{4}$ "	5 $\frac{1}{2}$ "	2 $\frac{5}{8}$ "	2"	1 $\frac{1}{2}$ "	26 cu. in.	(4) $\frac{3}{4}$ "	(2) $\frac{1}{2}$ "	(2) $\frac{1}{2}$ " & (2) $\frac{3}{4}$ "
743-S	10 $\frac{1}{4}$ "	5 $\frac{1}{2}$ "	2 $\frac{5}{8}$ "	2"	1 $\frac{1}{2}$ "	26 cu. in.	(6) $\frac{3}{4}$ "	(2) $\frac{1}{2}$ "	(3) $\frac{1}{2}$ " & (3) $\frac{3}{4}$ "
741-D	4"	5 $\frac{1}{2}$ "	3 $\frac{5}{8}$ "	2"	1 $\frac{1}{2}$ "	48 cu. in.	(2) $\frac{3}{4}$ "	(2)1 $\frac{1}{4}$ "	(1) $\frac{3}{4}$ " & (1)"
742-D	7 $\frac{1}{4}$ "	5 $\frac{1}{2}$ "	3 $\frac{5}{8}$ "	2"	1 $\frac{1}{2}$ "	41 cu. in.	(4) $\frac{3}{4}$ "	(2)1 $\frac{1}{4}$ "	(2) $\frac{1}{2}$ " & (2) $\frac{3}{4}$ "
743-D	10 $\frac{1}{4}$ "	5 $\frac{1}{2}$ "	3 $\frac{5}{8}$ "	2"	1 $\frac{1}{2}$ "	41 cu. in.	(6) $\frac{3}{4}$ "	(2)1 $\frac{1}{4}$ "	(3) $\frac{1}{2}$ " & (3) $\frac{3}{4}$ "

Carpet Activations for 740 Series

Cat. No.	Description	Finish	Std. Ctn.
641P-CACA	One-gang carpet trim	Aluminum	4
641P-CACB	One-gang carpet trim	Brass	4
641P-CAC-BGE	One-gang carpet trim	Nonmetallic Beige	4
641P-CAC-BLK	One-gang carpet trim	Nonmetallic Black	4
641P-CAC-GRY	One-gang carpet trim	Nonmetallic Gray	4
642P-CACA	Two-gang carpet trim	Aluminum	4
642P-CACB	Two-gang carpet trim	Brass	4
642P-CAC-BGE	Two-gang carpet trim	Nonmetallic Beige	4
642P-CAC-BLK	Two-gang carpet trim	Nonmetallic Black	4
642P-CAC-GRY	Two-gang carpet trim	Nonmetallic Gray	4
643P-CACA	Three-gang carpet trim	Aluminum	4
643P-CACB	Three-gang carpet trim	Brass	4
643P-CAC-BGE	Three-gang carpet trim	Nonmetallic Beige	4
643P-CAC-BLK	Three-gang carpet trim	Nonmetallic Black	4
643P-CAC-GRY	Three-gang carpet trim	Nonmetallic Gray	4

Steel City®

Flush Service Floor Boxes

Steel City®

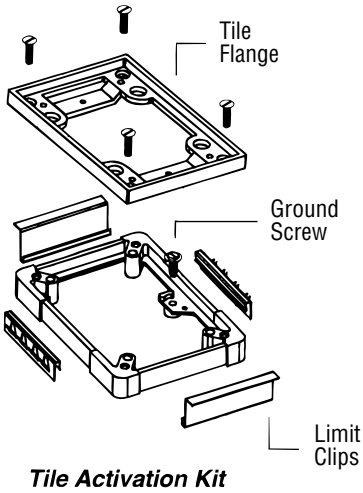

Tile Activation Kit



P-64-1/2
1/2" N.P.S. Plug

P-64-3/4
3/4" N.P.S. Plug



P-64-1
1" N.P.S. Plug



P-64-1-1/4
1 1/4" N.P.S. Plug

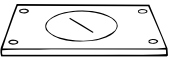

P-64-2*
2" Dia. Plug

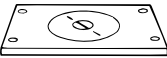

P-64-1/2-2*
1/2" & 2" Dia. Plug

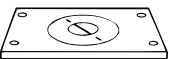

P-64-3/4-2*
3/4" & 2" Dia. Plug

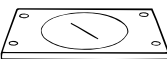

P-64-2-5/8*
2 5/8" Dia. Plug

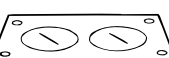

P-64-DU*
Duplex 1 7/16" Plugs



P-64-DS*
Duplex Lift lids



P-64-GFCI*
Brass Only

*Also includes steel seating plate for receptacles



P-64P-URC

Tile Activations for 740 Series

Cat. No.	Description	Finish	Std. Ctn.
641P-TACA	One-gang tile trim	Aluminum	4
641P-TACB	One-gang tile trim	Brass	4
641P-TAC-BGE	Nonmetallic	Beige	4
641P-TAC-BLK	Nonmetallic	Black	4
641P-TAC-GRY	Nonmetallic	Gray	4
642P-TACA	Two-gang tile trim	Aluminum	4
642P-TACB	Two-gang tile trim	Brass	4
642P-TAC-BGE	Nonmetallic	Beige	4
642P-TAC-BLK	Nonmetallic	Black	4
642P-TAC-GRY	Nonmetallic	Gray	4
643P-TACA	Three-gang tile trim	Aluminum	4
643P-TACB	Three-gang tile trim	Brass	4
643P-TAC-BGE	Nonmetallic	Beige	4
643P-TAC-BLK	Nonmetallic	Black	4
643P-TAC-GRY	Nonmetallic	Gray	4

Metallic Cover Plates for 740 Series

Cat. No.	Description	Finish	Std. Ctn.
P-64-1/2	1/2" N.P.S. Plug	Brass	4
P-64-3/4	3/4" N.P.S. Plug	Brass	4
P-64-1	1" N.P.S. Plug	Brass	4
P-64-1-1/4	1 1/4" Plug	Brass	4
P-64-2	2" Plug	Brass	4
P-64-1/2-2	1/2" & 2" Plug	Brass	4
P-64-3/4-2	3/4" & 2" Plug	Brass	4
P-64-2-5/8	Cover plate 2 5/8" UN plug	Brass	4
P-64-DU	Cover plate duplex 1 7/16" plugs	Brass	4
P-64-DS	Cover plate duplex lift lids	Brass	4
P-64-GFCI	Cover plate GFCI flip lid	Brass	4

- Polished brass finish.
- Furnished complete with sealing gasket and 8-32 x 1/16" brass screws.
- 3" x 4 1/2" outside dimension.
- For brushed aluminum, add AL after catalog number.
- All covers meet mop tight requirements.

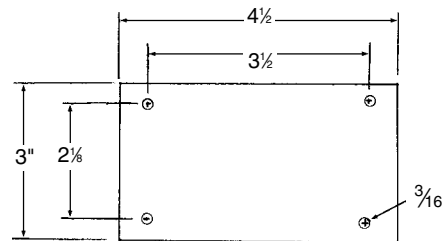

Nonmetallic Cover Plates for 740 Series

Cat. No.	Description	Color	Std. Ctn.
P64P-URC-BLK	Universal Cover	Black	4
P64P-URC-GRY	Universal Cover	Gray	4
P64P-URC-BGE	Universal Cover	Beige	4
P64P-BP-BLK	Blank Cover	Black	4
P64P-BP-GRY	Blank Cover	Gray	4
P64P-BP-BGE	Blank Cover	Beige	4

Thomas & Betts

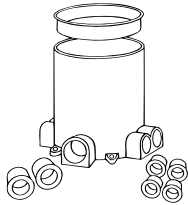

68-P

The Nonmetallic Floor Box is prepackaged with concrete cap and six hub plugs.

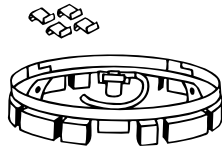

68-PAR

• Nonmetallic adjusting ring includes pigtail and clips.

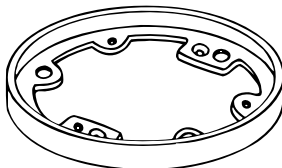

68P-FL/68P-FL-AL

Tile trim rings are available in brass or aluminum for flush installation of metallic plates in linoleum, wood or carpeted floors. Must be used to mount P60 series plates. (not required for P-68 covers, P60-CACP, or P60-3/4-2-CACP)

68-P Nonmetallic Floor Box



The 68-P floor box provides flush service for power or communications and data. The nonmetallic floor box is used in concrete floors and is suitable for carpet, tile, or wood applications.

- High-strength rigid PVC construction, non-corrosive.

- Easy installation with no leveling required – just cut the box level with the concrete after the pour.
- Compatible with standard schedule PVC conduit (1", 3/4" and 1/2", reducers included.)

68-P Round Nonmetallic Floor Box

Cat. No.	Dimensions			After Pour Adj.	Maximum Capacity (cu. in.)	Standard Conduit Tapping	Covers and Carpet Plates	Wiring Device	Std. Ctn.
	A	B	C						
68-P	5 5/32"	6"	6 3/8"	None	100	4—3/4" 2—1"	P60 P68 Series	Single Duplex or Data/Voice	8

Minimum pour 3 inches. Cubic in capacity is 17 cubic inches per inch of box height.

NOTE: Must use 68-PAR to attach cover plates to 68-P floor box.

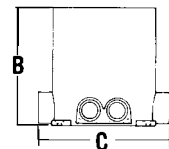
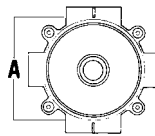

3/4" Wall Thickness

Adjusting Ring for 68-P Floor Box

Cat. No.	Description	Std. Ctn.
68-PAR*	Nonmetallic adjusting ring	8

*Required for all 68-P floorbox installations

Metallic Tile Trims for 68-P Floor Box

Cat. No.	Description	Std. Ctn.
68P-FL*	Tile trim ring, brass	4
68P-FL-AL*	Tile trim ring, aluminum	4

*Required to attach P60 Series cover plates to 68-P floor box.

Steel City®

Flush Service Floor Boxes

Steel City®

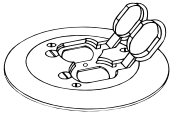

P60-CACP

One piece, solid brass duplex plate with screw-lock lids. 5/4" O.D.

Mounting holes on a 3/4" Dia.

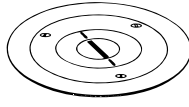

P60-3/4-2-CACP

One piece solid brass communications carpet plate. 5/4" O.D.

Mounting holes on a 3/4" Dia.

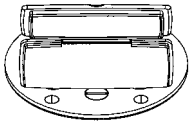

P60-CACP-GFCI



P60-CP

Metallic Carpet Plates for 68-P Floor Box

Cat. No.	Description	Std. Ctn.
P60-CACP	One piece duplex cover & carpet flange, brass	4
P60-CACP-AL	One piece duplex cover & carpet flange, aluminum	4
P60-3/4-2-CACP	One piece cover & carpet flange with 3/4" and 2" plugs, brass	4
P60-CACP-GFCI*	One piece GFCI cover and carpet flange, brass	4
P60-CP*	Carpet flange, brass	4
P60-CP-AL*	Carpet flange, aluminum	4

*Requires 68P-FL or 68P-FL-AL to attach covers to 68-P floor box.

- Polished brass finish.
- Furnished complete with 8-32 x 1" brass screws.
- For brushed aluminum, add AL after catalog number.



Metallic Cover Plates for 68-P Floor Boxes

Cat. No.	Description	Std. Ctn.
P-60-1/2	Brass cover plate 1/2" NPS plug size	4
P-60-1/2-AL	Aluminum cover plate 1/2" NPS plug size	4
P-60-3/4	Brass cover plate 3/4" NPS plug size	4
P-60-3/4-AL	Aluminum cover plate 3/4" NPS plug size	4
P-60-1	Brass cover plate 1" NPS plug size	4
P-60-1-AL	Aluminum cover plate 1" NPS plug size	4
P-60-1-1/4	Brass cover plate 1 1/4" NPS plug size	4
P-60-1-1/4-AL	Aluminum cover plate 1 1/4" NPS plug size	4
P-60-2	Brass cover plate 2" diameter plug size	4
P-60-2-AL	Aluminum cover plate 2" diameter plug size	4
P-60-2-5/8	Brass cover plate 2 5/8" diameter plug size	4
P-60-2-5/8-AL	Aluminum cover plate 2 5/8" diameter plug size	4
P-60-1/2-2	Brass cover plate 1/2"—2" diameter plug size	4
P-60-1/2-2-AL	Aluminum cover plate 1/2"—2" diameter plug size	4
P-60-3/4-2	Brass cover plate 3/4"—2" diameter plug size	4
P-60-3/4-2-AL	Aluminum cover plate 3/4"—2" diameter plug size	4
P-60-DR	Brass cover with duplex lift lid	4
P-60-DR-AL	Aluminum cover with duplex lift lid	4
P-60-DS	Brass cover for duplex with individual lift lids	4
P-60-DS-AL	Aluminum cover for duplex with individual lift lids	4
P-60-DU	Brass cover plate with 2—1 1/8" plugs for duplex	4
P-60-DU-AL	Aluminum cover with 2—1 1/8" plugs for duplex	4
P-60-GFCI	Brass cover plate for GFCI devices	4

NOTE: 68P-FL or 68P-FL-AL required to attach cover plates to 68-P floor box.

- Polished finish.
- Furnished complete with sealing gasket and 8-32 x 7/16" brass screws.
- 4" outside diameter.
- For brushed aluminum, add AL after catalog number.



P-60-1/2

1/2" N.P.S. Plug Size



P-60-3/4

3/4" N.P.S. Plug Size

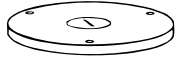

P-60-1

1" N.P.S. Plug Size

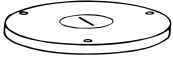

P-60-1-1/4

1 1/4" N.P.S. Plug Size



P-60-2*

2" Dia. Plug Size



P-60-2-5/8*

2 5/8" Dia. Plug Size

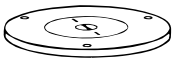

P-60-1/2-2*

1/2" & 2" Dia. Plug Size



P-60-3/4-2*

3/4" & 2" Dia. Plug Size



P-60-DU*
Duplex
1 1/8" Plugs



P-60-DR*
Duplex Lift Lid



P-60-DS*
Hinged Lift Lids



P-60-GFCI*

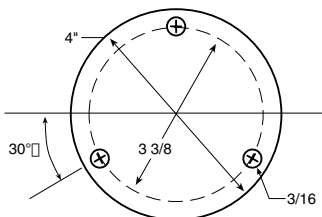

* Also includes steel seating plate for receptacles.

Flush Service Floor Boxes

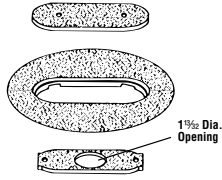

Nonmetallic, single receptacle plate (SRC) with matching carpet plate and cover. 6" O.D.

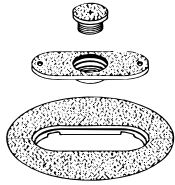

Nonmetallic floor service cover (FSC) with 1" NPS screw plug accommodates most above-floor service fittings with matching carpet plate. 6" O.D.

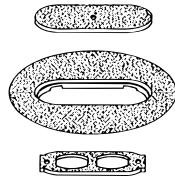

Nonmetallic, duplex/voice data receptacle plates (DRC) with matching carpet plate and cover. 6" O.D.

Nonmetallic Carpet Plates for 68-P Floor Box

Cat. No.	Color	Description	Std. Ctn.
P-68-SRC-GRY	Gray	Nonmetallic carpet plate & cover for single receptacle	4
P-68-SRC-BRN	Brown	Nonmetallic carpet plate & cover for single receptacle	4
P-68-SRC-BGE	Beige	Nonmetallic carpet plate & cover for single receptacle	4
P-68-FSC-GRY	Gray	Nonmetallic carpet plate and cover with 1" NPS screw plug	4
P-68-FSC-BRN	Brown	Nonmetallic carpet plate and cover with 1" NPS screw plug	4
P-68-FSC-BGE	Beige	Nonmetallic carpet plate and cover with 1" NPS screw plug	4
P-68-DRC-GRY	Gray	Nonmetallic carpet plate and cover for duplex receptacle	4
P-68-DRC-BRN	Brown	Nonmetallic carpet plate and cover for duplex receptacle	4
P-68-DRC-BGE	Beige	Nonmetallic carpet plate and cover for duplex receptacle	4

D

Steel City®

Steel City®

Flush Service Floor Boxes

Steel City®

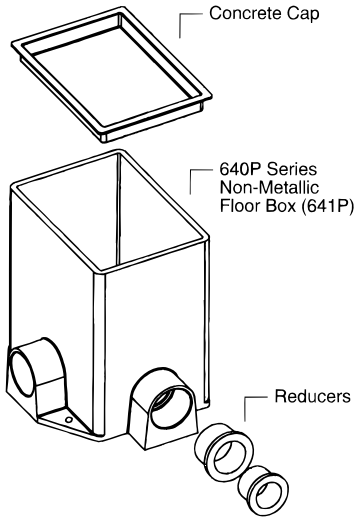

640P Series Nonmetallic Floor Boxes

Features

- Significant savings over metal boxes.
- Die-cast adjusting ring with unique "snap-on" feature which eliminates gluing.
- Reduced installation time; no leveling required.
- Compatibility with standard schedule PVC conduit; 1", 3/4" and 1/2".
- Removable Adjusting ring accepts wide variety of service accessories.
- One-piece housing unit with pre-molded conduit holes.
- Molded from a high-grade polymer material which is fully compatible with standard schedule PVC conduit.
- 640P Series Floor Boxes utilize both plastic and brass carpet (P64 series) plates and covers.
- Available in one, two, and three gang versions. Two and three gang boxes provided with partitions in corresponding activation kits
- Min. concrete pour 2 1/2".

640P Series Nonmetallic Floor Boxes

Cat. No.	Description	Dimensions			Max. Volume	Std. Ctn.
		Length	Width	Height		
641P	One Gang Box	4"	5 3/8"	6"	85.0 cu. in.	1
642P	Two Gang Box	7"	5 3/8"	6"	85.5 cu. in.*	1
643P	Three Gang Box	10 3/8"	5 3/8"	6"	85.5 cu. in.*	1

* Per gang

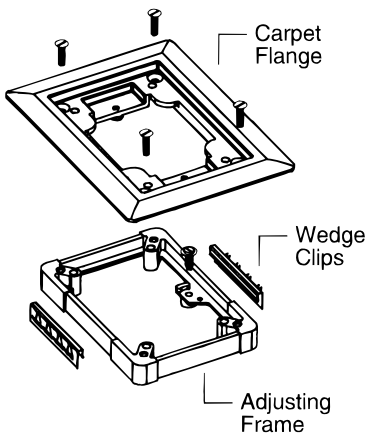

Carpet Activation Kit

Carpet Activations for 640P Series

Cat. No.	Description	Finish	Std. Ctn.
641P-CACA	One-gang carpet trim	Aluminum	4
641P-CACB	One-gang carpet trim	Brass	4
641P-CAC-BGE	One-gang carpet trim	Nonmetallic Beige	4
641P-CAC-BLK	One-gang carpet trim	Nonmetallic Black	4
641P-CAC-GRY	One-gang carpet trim	Nonmetallic Gray	4
642P-CACA	Two-gang carpet trim	Aluminum	4
642P-CACB	Two-gang carpet trim	Brass	4
642P-CAC-BGE	Two-gang carpet trim	Nonmetallic Beige	4
642P-CAC-BLK	Two-gang carpet trim	Nonmetallic Black	4
642P-CAC-GRY	Two-gang carpet trim	Nonmetallic Gray	4
643P-CACA	Three-gang carpet trim	Aluminum	4
643P-CACB	Three-gang carpet trim	Brass	4
643P-CAC-BGE	Three-gang carpet trim	Nonmetallic Beige	4
643P-CAC-BLK	Three-gang carpet trim	Nonmetallic Black	4
643P-CAC-GRY	Three-gang carpet trim	Nonmetallic Gray	4

Interior voltage dividers are supplied with all two and three gang activation kits.

Thomas & Betts

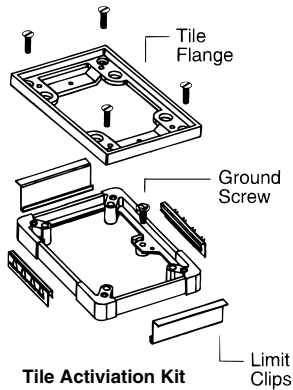

Tile Activation Kit



P-64-1/2
1/2" N.P.S. Plug



P-64-3/4
3/4" N.P.S. Plug



P-64-1
1" N.P.S. Plug

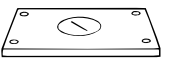

P-64-1-1/4
1 1/4" N.P.S. Plug



P-64-2*
2" Dia. Plug



P-64-1/2-2*
1/2" & 2" Dia. Plug

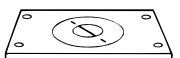

P-64-3/4-2*
3/4" & 2" Dia. Plug

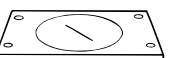

P-64-2-5/8*
2 5/8" Dia. Plug

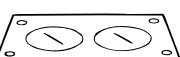

P-64-DU*
Duplex 1 7/16" Plugs



P-64-DS*
Duplex Lift lids

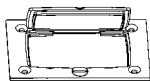

P-64-GFCI*
Brass Only

*Also includes steel seating plate for receptacles



P64P-URC

Tile Activations for 640P Series

Cat. No.	Description	Finish	Std. Ctn.
641P-TACA	One-gang tile trim	Aluminum	4
641P-TACB	One-gang tile trim	Brass	4
641P-TAC-BGE	Nonmetallic	Beige	4
641P-TAC-BLK	Nonmetallic	Black	4
641P-TAC-GRY	Nonmetallic	Gray	4
642P-TACA	Two-gang tile trim	Aluminum	4
642P-TACB	Two-gang tile trim	Brass	4
642P-TAC-BGE	Nonmetallic	Beige	4
642P-TAC-BLK	Nonmetallic	Black	4
642P-TAC-GRY	Nonmetallic	Gray	4
643P-TACA	Three-gang tile trim	Aluminum	4
643P-TACB	Three-gang tile trim	Brass	4
643P-TAC-BGE	Nonmetallic	Beige	4
643P-TAC-BLK	Nonmetallic	Black	4
643P-TAC-GRY	Nonmetallic	Gray	4

Interior voltage dividers are supplied with all two and three gang activation kits.

Metallic Cover Plates for 640P Series

Cat. No.	Description	Finish	Std. Ctn.
P-64-1/2	1/2" N.P.S. Plug	Brass	4
P-64-3/4	3/4" N.P.S. Plug	Brass	4
P-64-1	1" N.P.S. Plug	Brass	4
P-64-1-1/4	1 1/4" Plug	Brass	4
P-64-2	2" Plug	Brass	4
P-64-1/2-2	1/2" & 2" Plug	Brass	4
P-64-3/4-2	3/4" & 2" Plug	Brass	4
P-64-2-5/8	Cover plate 2 5/8" UN plug	Brass	4
P-64-DU	Cover plate duplex 1 7/16" plugs	Brass	4
P-64-DS	Cover plate duplex lift lids	Brass	4
P-64-GFCI	Cover plate GFCI flip lid	Brass	4

- Polished brass finish.
- Furnished complete with sealing gasket and 8-32 x 3/16" brass screws.
- 3" x 4 1/2" outside dimension.
- For brushed aluminum, add AL after catalog number.
- All covers meet mop tight requirements.

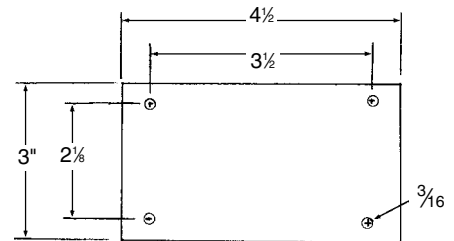

Nonmetallic Cover Plates for 640P Series

Cat. No.	Description	Color	Std. Ctn.
P64P-URC-BLK	Universal Cover	Black	4
P64P-URC-GRY	Universal Cover	Gray	4
P64P-URC-BGE	Universal Cover	Beige	4
P64P-BP-BLK	Blank Cover	Black	4
P64P-BP-GRY	Blank Cover	Gray	4
P64P-BP-BGE	Blank Cover	Beige	4

Steel City®

Flush Service Floor Boxes

Stamped Steel Floor Box Line for Use in Wood Floors

Steel City®

- Steel City has addressed the age old problem of installing power, voice or data services in wood floor applications.
- Be it a great room of a home, an auditorium, a gymnasium, school or commercial office building, the 61-W single gang and 62-W two gang floor boxes are the best designed products on the market to serve your needs.
- Adjustable design allows for various finished floor material heights. ie: hardwoods, parquet, tile or carpet.

New Construction (New Work) Applications

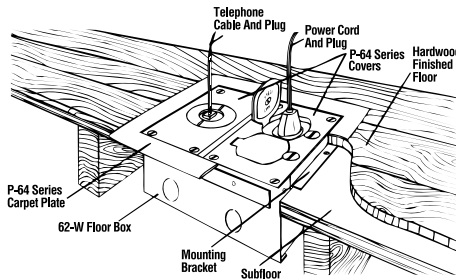

Retro-fit Construction (Old Work) Application

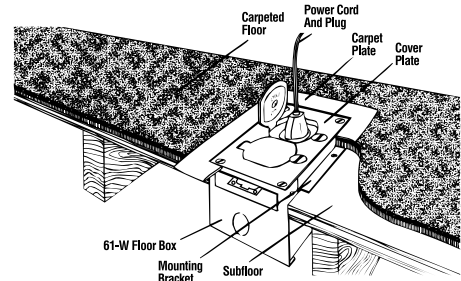

Stamped Steel Floor Box Line for Use in Wood Floors



61-W



62-W

Stamped Steel Floor Box Line for Use in Wood Floors

Cat. No.	Dimensions			Adjustment*	Capacity (in)	Knockouts	Std. Ctn.
	A	B	C				
61-W	5 $\frac{5}{16}$ "	3 $\frac{11}{16}$ "	2 $\frac{15}{16}$ "	1 $\frac{3}{16}$ "	31	Sides 2- $\frac{1}{2}$ Bottom 2- $\frac{1}{2}$	4
62-W	5 $\frac{5}{16}$ "	7"	2 $\frac{15}{16}$ "	1 $\frac{3}{16}$ "	30 ea. cell	Sides 4- $\frac{1}{2}$ Bottom 4- $\frac{1}{2}$	2

Material: .062 Galvanized Steel

Accessories:

Carpet Plate: 61-W uses P-64-CP Brass or P64PCP-xxx Nonmetallic.

62-W uses P-64-2G-CP Brass or P64P-2GCP-xxx Nonmetallic.

Covers: Both 61-W and 62-W can utilize any P-64 series brass or P64P-URC series Nonmetallic Covers.

Notes: * New work applications only.

Cover and Carpet plates are ordered separately.

Both the 61-W and 62-W come standard with a stamped steel protective cover.

New Work Mounting Brackets and Old Work Mounting Brackets come bagged inside box.

62W comes with partition to separate high and low voltage.

U.L. File No. E2969.

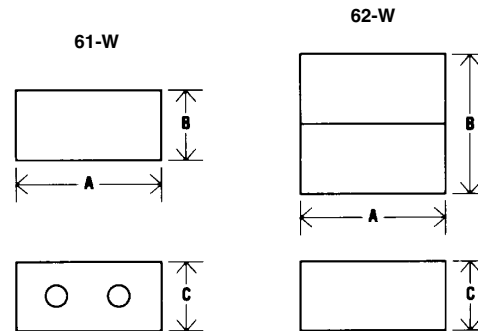

Steel City®

Above Floor Service Fittings

Steel City service fittings provide above-floor service for power, communications and data. A variety of service fitting designs are available.



SFH-40-RG

SFH-40 Series

- Brushed aluminum finish.
- Low profile design.
- Furnished with 1" conduit nipple.



SFH-50-2RG

SFH-50 Series

- Brushed aluminum finish.
- Interchangeable face plates.
- Furnished with 1" conduit nipple for direct screw-threading into a floor box plate with 1" cover opening.



SFL-10

- Brushed aluminum finish.
- Low profile design.
- Furnished with 1" conduit nipple.

Service Fittings for Power

Cat. No.	Description	Finish	Dimensions			Std. Ctn.
			W	D	H	
SFH-40-RG	Furnished with one 15 amp, 125 volt, 3-wire NEMA duplex receptacle	Brushed Aluminum	4 $\frac{3}{8}$ "	3"	2 $\frac{5}{8}$ "	4
SFH-40	Same as SFH-40-RG above less duplex receptacle	Brushed Aluminum	4 $\frac{3}{8}$ "	3"	2 $\frac{5}{8}$ "	4
SFH-50-2RG	Furnished with two back to back 15 amp, 125 volt, 3 wire NEMA duplex receptacles	Brushed Aluminum	5"	3 $\frac{3}{8}$ "	3"	4
SFH-50	Same as SFH-50-2RG less duplex receptacles	Brushed Aluminum	5"	3 $\frac{3}{8}$ "	3"	4
SFH-51	Furnished with cover plate to accommodate one 30 or 50 amp, 240 volt, 3 wire receptacle and blank cover	Brushed Aluminum	5"	3 $\frac{3}{8}$ "	3"	4

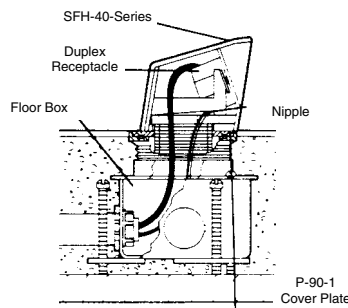

SFH-50-Base



SFH-51-COVER
Single Receptacle
Plate, 2.16" Hole



SFH-50-DUPCOV
Duplex
Receptacle Plate



SFH-50-CVW11332
Single Receptacle
Plate, 1.39" Hole



SFH-50-CVW11932
Single Receptacle
Plate, 1.60" Hole



SFH-50-BLCOV
Blank Plate



SFH-50-TELECOV
Telephone Plate,
1" Hole

Service Fittings for Communications and Data

Cat. No.	Description	Finish	Dimensions			Std. Ctn.
			W	D	H	
SFL-10	$\frac{3}{4}$ " x 1 $\frac{1}{8}$ " bushed opening for telephone or computer	Brushed Aluminum	4 $\frac{3}{8}$ "	3 $\frac{1}{8}$ "	2 $\frac{5}{8}$ "	4

Sample Application

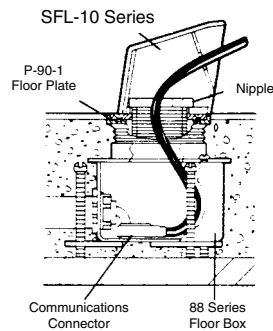

Thomas & Betts

For Series 78, 88 and 98, 671 or 672 Steel City® Floor Boxes

D

Steel City®



692



695

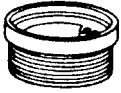

8805

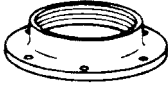

8803

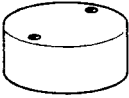

8818

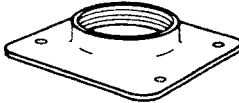

9803

Floor Plate Plug Inserts

Cat. No.	Size or Description	Std. Ctn.
690-SC	1/2"-14 NPS thread	4
691-SC	3/4"-14 NPS thread	4
692-SC	1"-11 1/2 NPS thread	4
693-SC	1 1/4"-11 1/2 NPS thread	4
694	2"-20 UN thread	4
695	1/2"-2"	4
696-SC	3/4"-2"	4

Catalog Numbers are for brass. For aluminum, add AL after catalog number.
2 5/8"-20 UN 2A Thread

Floor Box Body Parts

Cat. No.	Description	Std. Ctn.
8805-AL	Aluminum adjusting ring	4
8805	Brass adjusting ring	4
8803	Threaded steel body cover of '78' and '88' Series	4
8818	Metal protective cap	4
9803	Threaded steel body cover for '98' Series	4

2 5/8"-20 UN 2A Thread

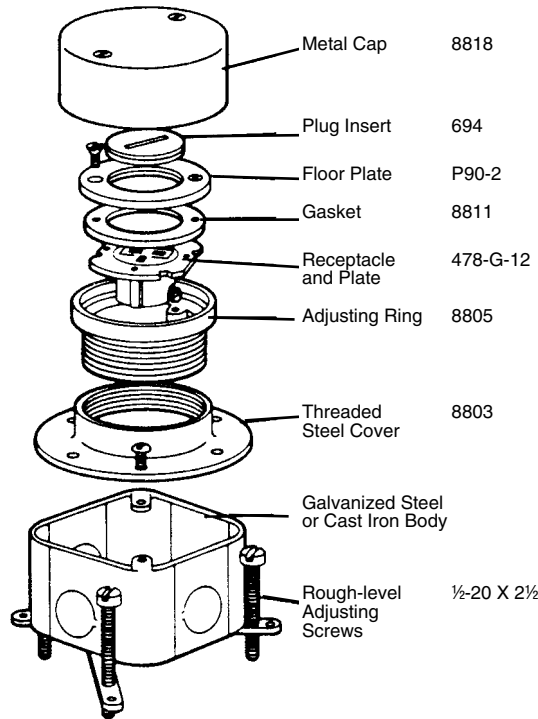

Floor Box Assembly with Floor Plate



Gasket for Floor Plate Assembly

Cat. No.	For Use With	Std. Ctn.
8811	P-90 Series Floor Plates	4

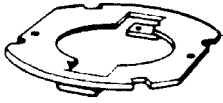

Receptacle Plate for Short Strap Single Receptacle

Cat. No.	For Use With	Std. Ctn.
889	Series 78, 88, 98, 671, 672 Boxes	4

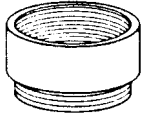

Extension Collar

Cat. No.	Description	Std. Ctn.
8805-E	Provides an extension of Floor Box throat upwards 1½"; for extreme depths (7 cu. in.)	4

2½-20 UN 2A Thread

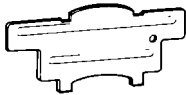

Wrench

Cat. No.	Description	Std. Ctn.
88W	For installing, positioning and removing floor plates and insert plugs; furnished free	4

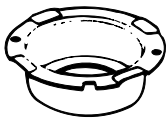

Microphone Adapter for Floor Boxes

Cat. No.	Description	Std. Ctn.
489-MA	27-ga. galvanized steel with 1¼" dia. opening for standard microphone jacks: for Steel City® Floor Box Series 78, 88, 98, and 671	4

Standard package 54.
Approximate weight 6 lbs. per C.

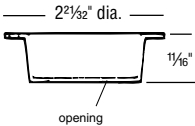

489-MA
1¼" dia.

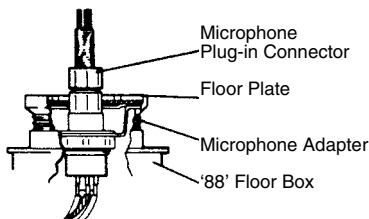

For Mounting Microphone Jacks in Floor Boxes –

The Microphone Adapter installs easily in the Steel City® Floor Box Tops and accommodates the microphone connector and locknut. The adapter is recessed to hold the microphone receptacle in position below the floor plate. Standard Floor Box Floor Plates, with removable 2" insert permits access to the receptacle (jack) for the microphone plug.

Sample Assemblies

For Carpet:

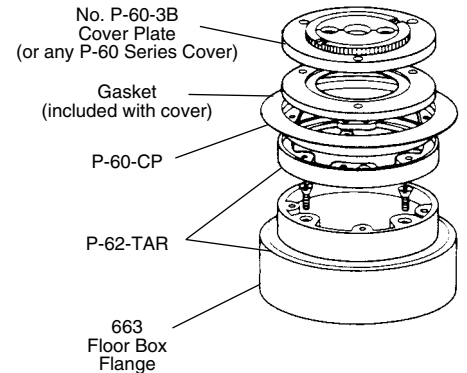
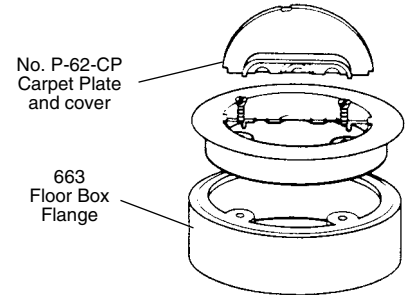

For Tile:

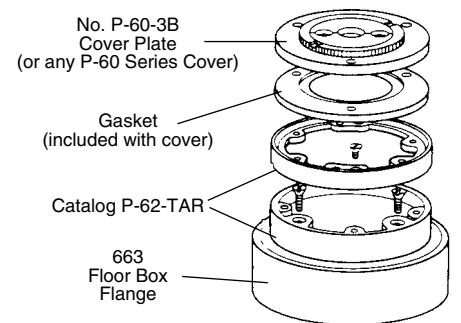

D

Steel City®

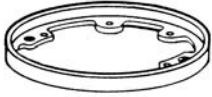

Series '600' Round Cast Iron Watertight Floor Boxes

Edge Rings for '600' Series

Cat. No.	Description	Std. Ctn.
600-4-FL-AL	Aluminum	4
600-4-FL	Brass	4

Floor Plate Plug Inserts

Cat. No.	Size or Description	Std. Ctn.
697	2 $\frac{1}{2}$ "-20-UN 2A thread	4
698	1 $\frac{1}{8}$ " for Duplex P-60-DU	4

For standard plug inserts $\frac{1}{2}$ " thru 2", see page D34. Catalog numbers are for brass. For aluminum, add AL after catalog number.

Gaskets for Floor Plate Assemblies

Cat. No.	For Use With	Std. Ctn.
630	P-60 Series Floor Plate assemblies (except duplex)	4
631	P-60-DR, P-60-DU, P-60-DC-AL, Floor Plate assemblies	4
P-60-DS-P3	P-60-DS Floor Plate assembly	1

Seating Plates for Receptacles-Steel

Cat. No.	For Use With	Std. Ctn.
630	P-60 Series Floor Plate assemblies (except duplex)	4
620	P-60-2, P-60- $\frac{1}{2}$ -2, P-60- $\frac{3}{4}$ -2 Floor Plate assemblies	1
621-SC	P-60-DR, P-60-DU, P-60-DC-AL and P-60-DS Floor Plate assemblies	1
622	P-60-2 $\frac{1}{2}$ Floor Plate assembly	1

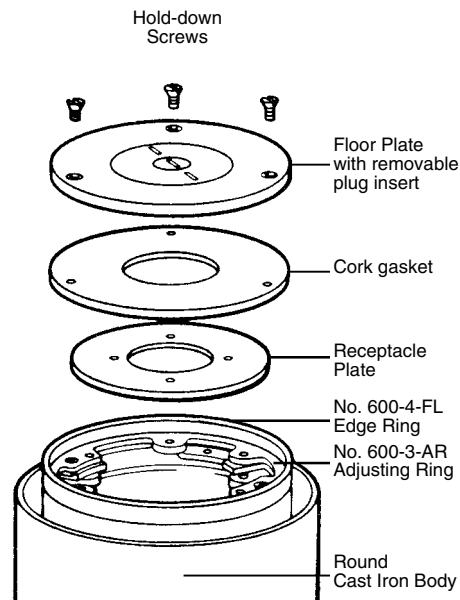



Series '640' and '840' Gang Cast Iron Watertight Floor Boxes – 1, 2, 3 Gang Boxes

Floor Plate Plug Inserts

Cat. No.	Size or Description	Std. Ctn.
697	2 $\frac{5}{8}$ "	4
698	1 $\frac{7}{16}$ " For Duplex P-64-DU	4

For standard plug inserts $\frac{1}{2}$ " thru 2", see page D34. Catalog numbers are for brass. For aluminum, add AL after catalog number.



Gaskets for Floor Plate Assemblies

Cat. No.	For Use With	Std. Ctn.
650	P-64 Series Floor Plate assemblies	4
651	P-64-DU, Floor Plate assemblies	10
P-64-DS-P2	P-64-DS Floor Plate assembly	4



Seating Plates for Receptacles—Steel

Cat. No.	For Use With	Std. Ctn.
640	P-64-2, P-64- $\frac{1}{2}$ -2, P-64- $\frac{3}{4}$ -2 Floor Plate assemblies	4
639	P-64-2 $\frac{5}{8}$ Floor Plate assemblies	1
638	P-64-DS and P-64-DU Floor Plate assemblies	1

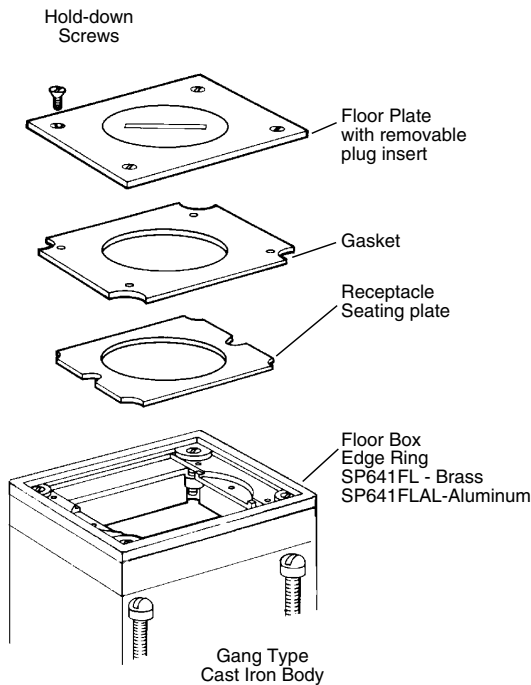

Floor Box Selection Chart

Steel City®

D

Cat. No.	Service Capabilities				Floor Box Body Material		Depth of Pour							Adjustability			
	Single Recept.	Duplex Recept.	GFCI Recept.	Multiple Service Capabilities	Cast Iron	Stamped Steel	2" and Above	2½" and Above	3" and Above	3½" and Above	4" and Above	4½" and Above	Wood Floor	Fully Adjustable	Semi Adjustable	Non-Adjustable	
663-SC		•		Two duplexes, two communications/data or one duplex with com./data		•								•			
664-S		•				•			•						•		
664-SC		•	•				•								•		
664-CI		•	•			•									•		
GAB-4, GAB-6		•	•	•							4¼"						
68-S	•	•	•		•			•									
68-D	•	•	•		•				•								
600	•	•	•						•								
601	•	•	•						•								
602	•	•	•					•									
603	•	•	•			•											
604	•	•	•		•							•					
68-P	•	•		High Strength Rigid PVC			•										
641	•	•	•	1 gang; 1 service per gang	•							•		•			
642	•	•	•	2 gang; 1 service per gang	•							•		•			
643	•	•	•	3 gang; 1 service per gang	•							•		•			
644	•	•	•	4 gang; 1 service per gang	•							•		•			
841	•	•	•	1 gang; 1 service per gang	•		•								•		
842	•	•	•	2 gang; 1 service per gang	•		•								•		
843	•	•	•	3 gang; 1 service per gang	•		•								•		
78-SC	•			•				•						•			
78-S	•			•				•						•			
88-D	•				•			•						•			
88-DA	•				•			•						•			
88-S	•				•			•						•			
98	•				•			•						•			
665		•	•	Up to 4 devices or any comb. of pwr. Com./data		•				•				•			
667SC		•	•	Up to 8 devices or any comb. of pwr. Com./data		•				•				•			
671-SC	•			•					•			•			•		
672	•			•					•			•			•		
SFL-10 Series				Com./data only.												•	
SFH-40 Series	•	•		Duplex												•	
SFH-50 Series	•	•		2 duplexes or low voltage.												•	
61W		•	•			•							•				
62W			•	2 duplexes, 2 com./data or 1 duplex with com./data		•							•			¾ Adjustment after installation	



Floor Box Cover Selection Chart

Floor Box Cat. No.	Description	Cover Plates	Brass	Carpet Activations Aluminum	Nonmetallic	Brass	Tile Activations Aluminum	Nonmetallic
663-SC	Concealed Service - Steel	P60 Series	P60-CP	P60-CPAL	P62-CP	P62-TAR	SP-P62-TAR-A;	N/A
664-SC	Concealed Service - Steel	664-CST-Series	N/A	N/A	664-CST Series	N/A	N/A	N/A
664S	Shallow Concealed Service - Steel	664-CST-Series	N/A	N/A	664-CST Series	N/A	N/A	N/A
664-CI	Concealed Service - Cast Iron	664-CST-Series	N/A	N/A	664-CST Series	N/A	N/A	N/A
68S	Flush Service - Steel	P60 Series	P60-CP P60-CACP	P60-CPAL P60-CACPAL	P60-LCP	*	**	
68D	Flush Service - Steel	P60 Series	P60-CP P60-CACP	P60-CPAL P60-CACPAL	P60-LCP	*	**	
68P	Flush Service - Nonmetallic	P60 Series	P60-CP P60-CACP	P60-CPAL P60-CACPAL	P68-SRC Color P68-DRC-Color P68-ECC-Color	68-PAR-W/ 600-4-FL	68-PAR-W/ 600-4-FL-AL	
600-SC Series	Flush Service - Cast Iron	P60 Series	P60-CP P60-CACP	P60-CPAL P60-CACPAL	N/A	*	**	
601-SC Series	Flush Service - Cast Iron	P60 Series	P60-CP P60-CACP	P60-CPAL P60-CACPAL	N/A	*	**	
602-SC Series	Flush Service - Cast Iron	P60 Series	P60-CP P60-CACP	P60-CPAL P60-CACPAL	N/A	*	**	
603-SC Series	Flush Service - Cast Iron	P60 Series	P60-CP P60-CACP	P60-CPAL P60-CACPAL	N/A	*	**	
604-SC Series	Flush Service - Cast Iron	P60 Series	P60-CP P60-CACP	P60-CPAL P60-CACPAL	N/A	*	**	
641	Flush Service - Cast Iron	P64 Series	P64-CP	P64-CPAL	P64P-CP Series P64-LCP	*	**	N/A
641P	Flush Service - Nonmetallic	P64 Series P64P Series	641P-CACB	641P-CACA	641P-CAC Series	641P-TACB	641P-TACA	641P-TAC Series
642	Flush Service - Cast Iron	P64 Series	P64-2GCP	P64-2GCPAL	P64P-2GCP Series P64-2LCP	*	**	N/A
642P	Flush Service - Nonmetallic	P64 Series P64P Series	642P-CACB	642P-CACA	642P-CAC Series	642P-TACB	642P-TACA	642P-TAC Series
643	Flush Service - Cast Iron	P64 Series	P64-3GCP	P64-3GCPAL	P64P-3GCP Series P64-3LCP	*	**	N/A
643P	Flush Service - Nonmetallic	P64 Series P64P Series	643P-CACB	643P-CACA	643P-CAC Series	633P-TACB	643P-TACA	643P-TAC Series
644	Flush Service - Cast Iron	P64 Series	P64-4GCP	P64-4GCPAL	N/A	*	**	N/A
841-SC	Shallow Flush Service - Cast Iron	P64 Series	P64-CP	P64-CPAL	P64P-CP Series P64-LCP	*	**	N/A
842-SC	Shallow Flush Service - Cast Iron	P64 Series	P64-2GCP	P64-2GCPAL	P64P-2GCP Series P64-2LCP	*	**	
843-SC	Shallow Flush Service - Cast Iron	P64 Series	P64-3GCP	P64-3GCPA;	P64P-3GCP Series P64-3LCP	*	**	N/A
78-SC	Flush service - Cast Iron	P90 Series	P90-CP	P90-CPAL	N/A	*	**	N/A
78S	Flush Service - Cast Iron	P90 Series	P90-CP	P90-CPAL	N/A	*	**	N/A
671	Flush Service - Cast Iron	P67 Series	P90-CP	P90-CPAL	N/A	*	**	N/A
672	Flush Service - Cast Iron	P67 Series	P90-CP	P90-CPAL	N/A	*	**	N/A
88D	Flush Service - Steel	P90 Series	P90-CP	P90-CPAL	N/A	*	**	N/A
88DA	Flush Service - Steel	P90 Series	P90-CP	P90-CPAL	N/A	*	**	N/A
88S	Flush Service - Steel	P90 Series	P90-CP	P90-CPAL	N/A	*	**	N/A
98	Flush Service	P90 Series	P90-CP	P90-CPAL	N/A	*	**	N/A
665-SC	Concealed Service	665-CST Series	N/A	N/A	665-CST Series			
667	Concealed Service	667-CST Series	N/A	N/A	667-CST Series			
61W	Flush Service - Steel	P64 Series	P64-CP	P64-CPAL	P64P-CP Series	N/A	N/A	N/A
62W	Flush Service - Steel	P64 Series	P64-2GCP	P64-2GCPAL	P64P-2GCP Series	N/A	N/A	N/A

*Supplied standard with box
 **Supplied standard with -AL suffix box
 N/A - Not Available

D
Steel City®

Steel City®

Floor Box Covers

Steel City®

D

Cover Series	Cover Cat. No.	Description	Standard Finish
P60 4" Dia.	P60-1/2	½" N.P.S. Plug	Polished Brass
	P60-1/2-AL	½" N.P.S. Plug	Brushed Aluminum
	P60-3/4	¾" N.P.S. Plug	Polished Brass
	P60-3/4-AL	¾" N.P.S. Plug	Brushed Aluminum
	P60-1	1" N.P.S. Plug	Polished Brass
	P60-1-AL	1" N.P.S. Plug	Brushed Aluminum
	P60-1 1/4	1 ¼" N.P.S. Plug	Polished Brass
	P60-1 1/4-AL	1 ¼" N.P.S. Plug	Brushed Aluminum
	P60-2	2" Dia. Plug	Polished Brass
	P60-2-AL	2" Dia. Plug	Brushed Aluminum
	P60-2 5/8	2 ⅝" Dia. Plug	Polished Brass
	P60-2 5/8-AL	2 ⅝" Dia. Plug	Brushed Aluminum
	P60-1/2-2	½" N.P.S. & 2" Dia. Plugs	Polished Brass
	P60-1/2-2-AL	½" N.P.S. & 2" Dia. Plugs	Brushed Aluminum
	P60-3/4-2	¾" N.P.S. & 2" Dia. Plugs	Polished Brass
	P60-3/4-2-AL	¾" N.P.S. & 2" Dia. Plugs	Brushed Aluminum
	P60-DU	Two 1 ⅞" Dia. Plugs	Polished Brass
	P60-DU-AL	Two 1 ⅞" Dia. Plugs	Brushed Aluminum
P60-DS	Two Hinged Lift Lids	Polished Brass	
P60-DS-AL	Two Hinged Lift Lids	Brushed Aluminum	
P60-DR	Single Hinged Lift Lid	Polished Brass	
P60-DR-AL	Single Hinged Lift Lid	Brushed Aluminum	
P60-GFCI	GFCI Hinged Lift Lid	Polished Brass	
P60-CACP One Piece 5 3/4" Dia.	P60-CACP	One Piece Carpet Plate with Two Hinged Lift Lids for Duplex	Polished Brass
	P60-CACP-AL	One Piece Carpet Plate with Two Hinged Lift Lids for Duplex	Brushed Aluminum
	P60-CACP-GFCI	One Piece Carpet Plate with Two w/ GFCI Hinged Lift Lid	Polished Brass
P67 3 1/2" Dia.	P60-3/4-2-CACP	One Piece Carpet Plate with 3s ¾" N.P.S. & 2" Dia. Plug	Polished Brass
	P60-3/4-2-CACP-AL	One Piece Carpet Plate with ¾" & 2" N.P.S. Plugs	Brushed Aluminum
	P67-1/2	½" N.P.S. Plug	Polished Brass
P67-3/4	¾" N.P.S. Plug	Polished Brass	
P67-3/4-AL	¾" N.P.S. Plug	Brushed Aluminum	
P67-1	1" N.P.S. Plug	Polished Brass	
P67-1AL	1" N.P.S. Plug	Brushed Aluminum	
P67-1 1/4	1 ¼" N.P.S. Plug	Polished Brass	
P67-2	2" Dia. Plug	Polished Brass	
P67-2AL	2" Dia. Plug	Brushed Aluminum	
P67-1/2-2	½" N.P.S. & 2" Dia. Plugs	Polished Brass	
P67-3/4-2	¾" N.P.S. & 2" Dia. Plugs	Polished Brass	

Cover Series	Cover Cat. No.	Description	Standard Finish
P64 3" x 4 1/2" Rectangu- lar	P64-1/2	½" N.P.S. Plug	Polished Brass
	P64-1/2AL	½" N.P.S. Plug	Brushed Aluminum
	P64-3/4	¾" N.P.S. Plug	Polished Brass
	P64-3/4AL	¾" N.P.S. Plug	Brushed Aluminum
	P64-1	1" N.P.S. Plug	Polished Brass
	P64-1AL	1" N.P.S. Plug	Brushed Aluminum
	P64-1 1/4	1 ¼" N.P.S. Plug	Polished Brass
	P64-1 1/4AL	1 ¼" N.P.S. Plug	Brushed Aluminum
	P64-2" N.P.S. Plug	2" N.P.S. Plug	Polished Brass
	P64-2" N.P.S. Plug	2" N.P.S. Plug	Brushed Aluminum
	P64-1/2-2	½" & 2" N.P.S. Plug	Polished Brass
	P64-1/2-2AL	½" & 2" N.P.S. Plug	Brushed Aluminum
	P64-3/4-2	¾" & 2" N.P.S. Plug	Polished Brass
	P64-3/4-2AL	¾" & 2" N.P.S. Plug	Brushed Aluminum
	P64-2-5/8	2 ⅝" N.P.S. Plug	Polished Brass
	P64-2-5/8AL	2 ⅝" N.P.S. Plug	Brushed Aluminum
	P64-DU	Two 1 ⅞" Dia. Plugs	Polished Brass
	P64-DUAL	Two 1 ⅞" Dia. Plugs	Brushed Aluminum
P64-D8	Two Hinged Lift Lids	Polished Brass	
P64-GFCI	GFCI Hinged Lift Lid	Polished Brass	
P64P	P64P-BP	Blank Plate	Nonmetallic
	P64P-URC	Universal Cover	Nonmetallic
	P90-1/2	½" N.P.S. Plug	Polished Brass
P90 2 3/4" Dia.	P90-1/2AL	½" N.P.S. Plug	Brushed Aluminum
	P90-3/4	¾" N.P.S. Plug	Polished Brass
	P90-3/4AL	¾" N.P.S. Plug	Brushed Aluminum
	P90-1	1" N.P.S. Plug	Polished Brass
	P90-1AL	1" N.P.S. Plug	Brushed Aluminum
	P90-1 1/4	1 ¼" N.P.S. Plug	Polished Brass
	P90-1 1/4AL	1 ¼" N.P.S. Plug	Brushed Aluminum
	P90-2	2" Dia. Plug	Polished Brass
	P90-2AL	2" Dia. Plug	Brushed Aluminum
	P90-1/2-2	½" N.P.S. & 2" Dia. Plugs	Polished Brass
	P90-1/2-2AL	½" N.P.S. & 2" Dia. Plugs	Brushed Aluminum
	P90-3/4-2	¾" N.P.S. & 2" Dia. Plugs	Polished Brass
	P90-3/4-2AL	¾" N.P.S. & 2" Dia. Plugs	Brushed Aluminum
	P68-SRC-GRY	Carpet & Cover Plate for Single Receptacle	Nonmetallic Gray
	P68-SRC-BRN	Carpet & Cover Plate for Single Receptacle	Nonmetallic Brown
	P68-SRC-BGE	Carpet & Cover Plate for Single Receptacle	Nonmetallic Beige
	P68-FSC-GRY	Carpet & Cover Plate with 1" N.P.S. Plug	Nonmetallic Gray
	P68 6" Dia.	P68-FSC-BRN	Carpet & Cover Plate with 1" N.P.S. Plug
P68-FSC-BGE		Carpet & Cover Plate with 1" N.P.S. Plug	Nonmetallic Beige
P68-DRC-GRY		Carpet & Cover Plate for Duplex Receptacle	Nonmetallic Gray
P68-DRC-BRN	Carpet & Cover Plate for Duplex Receptacle	Nonmetallic Brown	
P68-DRC-BGE	Carpet & Cover Plate for Duplex Receptacle	Nonmetallic Beige	

Thomas & Betts

Standard Specification – FB Floor Boxes

Cast Iron Formed Steel

Considerations when writing specifications:

Floor boxes are manufactured in various sizes, configurations and materials. The specifier should determine the most suitable product for his application. Refer to the T&B floor box catalog and select the appropriate paragraphs listed below. Plans should supply wiring capacity, conduit sizes, adjustability and floor finish. Construction Specifications Institute (CSI) references sections: 16132 Floor Boxes; 16141 Wiring Devices; Part 2-206 Floor Mounted Service Fittings; and 16741 Telephone Raceway Systems, Part 2-201 G Floor Boxes. Section 16132 Floor Boxes is preferable.

PART 2: PRODUCTS

2.01 ACCEPTABLE MANUFACTURERS – FLOOR BOXES

- A. Shall be as manufactured by Thomas & Betts, Memphis, TN

2.02 MATERIALS – FLOOR BOXES

2.02.1

- A. Shall be cast iron, painted inside and out with weatherproof paint intended for use on metal as indicated on the plans.

2.02.1

- B. Shall be formed steel with a zinc or cadmium plating at least .0005 in. thick on the outside and .00015 in. thick on the inside as indicated on the plans.

2.02.2

- A. Construction shall be as required by U.L. 514A.

2.02.2

- B. Carpet or tile frame shall be (brass, aluminum, polycarbonate, nylon).

2.02.2

- C. Cover assembly shall protect against the ingress of water or foreign material with a gasket and shall be U.L. listed as moptight.

2.03 GENERAL DESIGN – FLOOR BOXES

- A. Shall deliver electric power from receptacles installed at the surface of the floor or from service fittings (Reference 16141 as shown on the plans).
- B. 640/840 Series shall deliver power and telephone/data cable without interference from electric power delivery (see Section 16741).
- C. Cubic inch capacity shall be as shown on the plans.
- D. Boxes shall accept conduit sizes as required on the plans.
- E. Shall be listed by Underwriters' Laboratories.

PART 3: EXECUTION

3.01 GENERAL

- A. Locate position for floor boxes and runs of conduit as shown on the plans.

3.01 INSTALLATION

- A. Position floor boxes and conduit runs.
- B. After concrete pour, pull wires and install devices according to manufacturers recommendations.
- C. Activate in accordance with the National Electrical Code.
- D. Coordinate with floor covering contractor to complete installation.

Standard Specification- CSFB Concealed Service

Service Floor Outlet Multiple Service, Power and Communications

Considerations when writing specifications:

The 664 Concealed Service Floor Box provides both electric power and telephone (data) services from the same device for economy of space and cost, as well as affording a flush delivery (no above floor service fitting). For these reasons, your specification may reference this product in three sections; Floor Boxes, Wiring Devices, and Telephone Raceway Systems. Construction Specifications Institute (CSI) references them in: 16132 Floor Boxes; 16141 Wiring Devices; Part 2—2.06 Floor Mounted Service Fittings; and 16741 Telephone Raceway Systems, Part 2—2.01 G Floor Boxes. Section 16132 Floor Boxes is preferable. For clarification include a reference in 16141, Part 2, 2.06 Floor Mounted Service Fittings as follows: Surface type service fittings are not acceptable.

PART 2: PRODUCTS

2.01 ACCEPTABLE MANUFACTURERS—FLOOR BOXES, MULTIPLE SERVICE.

- A. Shall be series 664 concealed service floor box as manufactured by Thomas & Betts.

2.02 MATERIALS—FLOOR BOXES, MULTIPLE SERVICE.

- A. Shall be electrogalvanized, 14 gauge sheet steel. (Alternate A shall be cast iron).
- B. Construction shall be as required by U.L. 514A.
- C. Carpet frame shall be nylon U.L. Recognized Component QMFZ2.
- D. Hinged outer cover shall be reinforced with a 5/32" steel plate.

2.03 GENERAL DESIGN – FLOOR BOXES, MULTIPLE SERVICE.

- A. Shall deliver electric power from one or two duplex receptacles installed below the surface of the floor.
- B. Shall deliver telephone or data cable without interference from the electric power delivery.
- C. Shall protect delivery of both services by a hinged cover with a retractable opening and foam plastomer dust seal.
- D. Hinged cover shall accept carpet or tile to match floor covering and be 180 degrees reversible.
- E. Shall have 90 cubic inch total capacity with 24 cubic inch power chambers.
- F. Shall accept conduit sizes up to 1¼ inches.
- G. Shall afford 18 square inches of access with cover open.
- H. Box shall be listed by Underwriters Laboratories.
- I. When hinged cover is closed and no services in place, device shall have no obstructions above surface of floor.

PART 3: EXECUTION

3.01 GENERAL

- A. Locate position for floor boxes and runs of conduit as shown on the plans.

3.02 INSTALLATION

- A. Position floor boxes and conduit runs.
- B. After concrete pour pull wires and install devices according to manufacturers recommendations.
- C. Activate in accordance with the National Electric Code.
- D. Coordinate with floor covering contractor to complete installation.

Standard Specification – SFH Service Fitting Heads

Polished Brushed Aluminum Finish

Considerations when writing specifications:

Service fitting heads are manufactured in various sizes, configurations and materials. The specifier should determine the most suitable product for his application. Refer to the T&B floor box catalog and select the appropriate paragraphs listed below. Construction Specifications Institute (CSI) references sections: 16141 Floor Mounted Service Fitting Heads, Wiring Devices; 16741 Telephone Raceway. Section 16141 is preferable.

PART 2: PRODUCTS

2.01 ACCEPTABLE MANUFACTURERS – SERVICE FITTING HEADS

- A. Shall be manufactured by Thomas & Betts, Memphis, TN.

2.02 MATERIALS – SERVICE FITTING HEADS

- A. Shall be brushed aluminum.

2.03 GENERAL DESIGN – SERVICE FITTINGS

- A. Shall deliver electrical power from receptacles as designated on the plans.
- B. Shall deliver telephone/data through precut bushed opening.
- C. Shall be furnished standard with required receptacles.
- D. Shall be furnished standard with conduit nipple for direct screw threading into Thomas & Betts cover assembly.
- E. Shall be listed by Underwriters Laboratories.

PART 3: EXECUTION

3.01 GENERAL

- A. Locate position for floor boxes and runs of conduit as shown on the plans.

3.02 INSTALLATION

- A. Position floor boxes and conduit runs.
- B. After concrete pour, install service fitting heads, pull wires and install devices according to manufacturer's recommendations.
- C. Activate in accordance with the National Electrical Code.
- D. Coordinate with floor covering contractor to complete installation.

Steel City®

Access Floor Modules

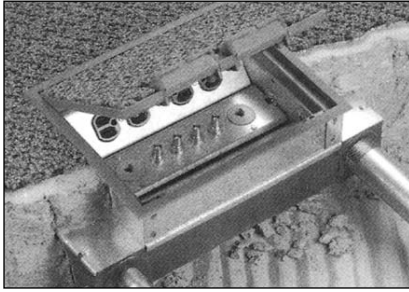

Steel City® Access Floor Modules from Thomas & Betts eliminate the clutter of power, voice, and data lines by keeping everything out of sight but conveniently close at hand. Our easy-to-install Access Floor Modules are designed to blend with any decor, while providing the durability and versatility you need to meet the growing demands of today's high-tech offices.

You can use our Access Floor Modules with virtually any type of raised floor, including ridged or waffled floor panels, carpet or tile floors. Our system is designed to provide a simple, strong, and adaptable solution to even the most demanding wire management needs.

Range Of Box Sizes Designed to Meet The Needs Of Any Application. Now And Later.

With five sizes to choose from, our Access Floor Modules handle a broad range of wiring needs, from single power lines to complex data and voice systems. In fact, our largest unit offers 325 cu. in. of space, making it the roomiest in the industry. And because our modules are easy to install and relocate, you can easily change box sizes or reposition modules as office configurations change.

New, Low-Profile Box Fits Right In With Shallower Raised Floors.

For installations where shallower raised floors are needed, Thomas & Betts has developed a low-profile Access Floor Module to provide the same accessibility and convenience where space is at a premium. Just 2½ inches deep, it can still accommodate a variety of power, voice, and data connections.

Wide Variety Of Interchangeable Power and Data Panels Adapt To Changing Demands.

Our extensive line of panels and connection devices maximizes the versatility of our Access Floor Modules. All our panels are designed to be easy to connect, disconnect, and rearrange to reduce on-site installation time. And Thomas & Betts is continually developing new configurations to meet the requirements of virtually any installation, especially for the fast-growing needs of voice and data communication.

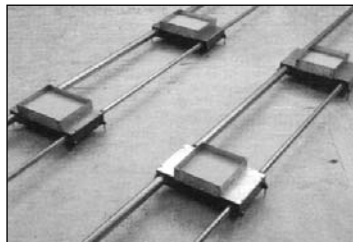

Durable, Solid Steel Covers Support Heavy Loads To Protect Important Connections.

We've reinforced the resilient nylon covers of our modules with a 5/8" steel plate, to prevent buckling under heavy furniture and equipment. The beveled sides allow for quick and unobstructed installation in the raised floor.

In addition, our retractable exit not only helps prevent tripping but protects cable connections by sealing out dust and debris. And, as with all Thomas & Betts products, our Access Floor Modules are constructed to meet your high standards for durability, safety, and reliability.

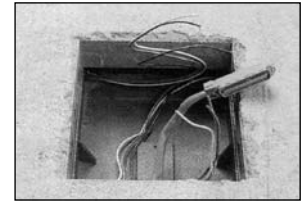

Steel City® Access Floor Modules Provide Outstanding Performance Without Standing Out.

The hinged service top on our modules sits flush with the floor and provides complete access to the connections within. The nylon frame comes in gray, brown, beige, and black; and it accepts field-installed carpets or tile, as well as factory-provided high-pressure laminate inserts for specific project requirements.

Our Access Floor Modules keep wire connections close-at-hand but not under foot. The widest variety of box sizes, panels, and devices in the industry provides exceptional versatility for changing office needs.

Look below the surface and see how Steel City Access Floor Modules can manage all your power, voice, and data connections. Today and tomorrow.

D

Steel City®

Thomas & Betts









AFM-2 Access Floor Module

Access Floor Module Size		AFM-2
AFM Depth		4"
Access Floor Cut-Out		7 1/8" x 4 1/8"
AFM Cover Size		6 3/4" x 3 7/8"
AFM Cover Access Area		17 sq in
Box Volume (Less Panels)		75 cu in
Device		
Compartment	45° Power	16.2 cu in.
Volume		
Base Opening		—
Power Panel Included**		AFP-2A
Closure Panel Included		—
Cover/Carpet Flange Material		Nylon-6
Body Material		14 ga galvanized steel
Prewiring Available		Yes*
Max. No. of Device Panels		2

* Special Panels Available — Consult Factory

** Devices not included

Available with black (-BLK), brown (-BRN), beige (-BGE), or gray (-GRY) cover flange.

AFM	POWER PANELS	
AFM-2-BLK GRY BRN BGE	 AFP-2A* single duplex	 AFP-2B blank
DATA PANELS		ACCESSORIES
 AFD-2J 1 IBM set	 AFD 2E 1 T&B epitome	 AFD-2 3RJ 3 T&B omnijacks or keystone style jacks
		 AFT-2 power tunnel
		 AFR-2** mounting flange

* (1) supplied with box

** Used to correct opening in floor. Not required for all installations.

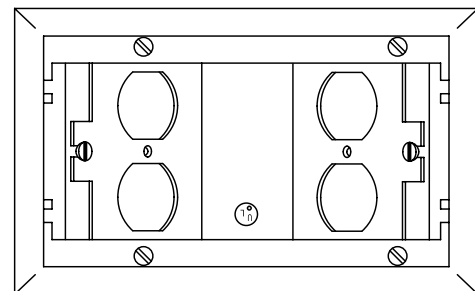
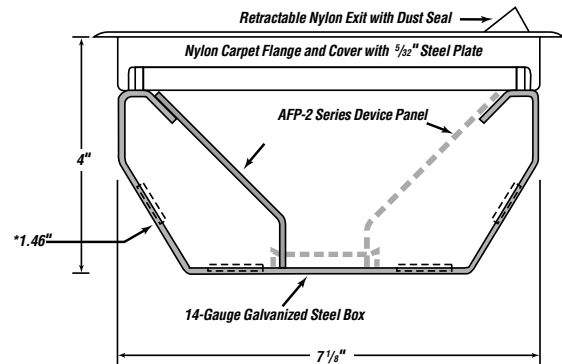

AFM-2

Shown with supplied power panel and optional panel (sold separately).

Steel City®

Access Floor Modules



AFM-4 Access Floor Module

Access Floor Module Size	AFM-4
AFM Depth	4"
Access Floor Cut-Out	7 ¹⁵ / ₁₆ " x 7 ¹⁵ / ₁₆ "
AFM Cover Size	7 ⁹ / ₈ " x 7 ⁹ / ₈ "
AFM Cover Access Area	39 sq in
Box Volume (Less Panels)	150 cu in
45° Power	27.3 cu in
60° Power	25.2 cu in
Center Data	20.6 cu in
Power	—
Data	—
Base Opening	2" x 2 ⁷ / ₈ "
Power Panel Included**	AFP-4A
Closure Panel Included	AFC-C
Cover/Carpet Flange Material	Nylon-6
Body Material	14 ga galvanized steel
Prewiring Available	Yes*
Max. No. of Device Panels	3

D

Steel City®

POWER PANELS

AFM-4-BLK GRY BRN BGE	AFP-4A* single duplex-45°	AFP-4A60 single duplex-45°	AFP-4-GFCI single GFCI-60°
	AFP-4B blank-45°	AFP-4B60 blank-60°	

* Special Panels Available — Consult Factory

** Devices not included

Available with black (-BLK), brown (-BRN), beige (-BGE), or gray (-GRY) cover flange.

DATA PANELS

AFD-4A single duplex data	AFD-4B Blank
AFD-4 4RJ T&B Omni jacks or Keystone style jacks	

ACCESSORIES

AFT-46 power tunnel	AFR-4** mounting flange
AFC-N grommeted closure panel	AFM-4EX extension collar

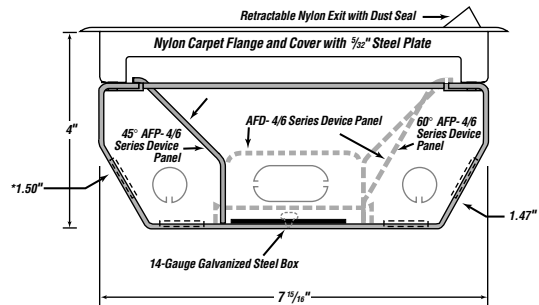

* (1) ea. supplied with box.

** Used to correct opening in floor. Not required for all installations.

Shown with supplied power panel and optional data panel and 45° power panel (sold separately).

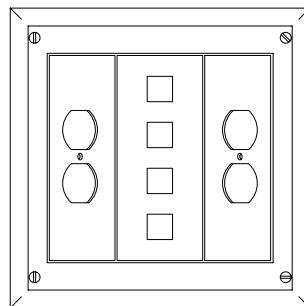

45° Angle Plates

Shown with optional 60° power panels (sold separately).

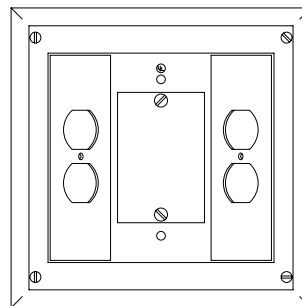

60° Angle Plates

Thomas & Betts

Steel City®

Access Floor Modules



Steel City®

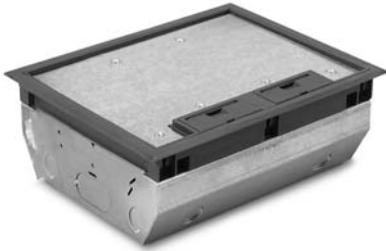

AFM-6 Access Floor Module

Access Floor Module Size	AFM-6
AFM Depth	4
Access Floor Cut-Out	7 ¹⁵ / ₁₆ " x 10"
AFM Cover Size	7 ⁵ / ₈ " x 9 ³ / ₄ "
AFM Cover Access Area	60 sq in
Box Volume (Less Panels)	225 cu in
Device	45° Power 41.5 cu in
Compartment	60° Power 38.3 cu in
Volume	Center Data 31.3 cu in
	Power —
	Data —
Base Opening	2" x 2 ⁷ / ₈ "
Power Panel Included**	AFP-6Q
Closure Panel Included	AFC-C
Cover/Carpet Flange Material	Nylon-6
Body Material	14 ga galvanized steel
Prewiring Available	Yes*
Max. No. of Device Panels	3

* Special Panels Available — Consult Factory

** Devices not included

Available with black (-BLK), brown (-BRN), beige (-BGE), or gray (-GRY) cover flange.

AFM	POWER PANELS	
AFM-6-BLK GRY BRN BGE	AFP-6Q* single duplex-45°	AFP-6B blank-45°
	AFP-6A single duplex-45°	AFP-6B60 blank-45°
	AFP-6R60 double duplex-60°	AFP-6-GFCI double GFCI-60°
	AFP-6A60 Single duplex-60°	AFP-6-GFCI-45 double GFCI-45°

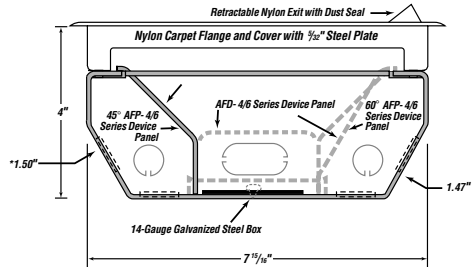

DATA PANELS		ACCESSORIES
AFD-60 double duplex data	AFD-6M 2 telephone - 4 coax	AFT-46 power tunnel
AFD-6L 2 IBM sets	AFD-6B blank	AFR-4** mounting flange
AFD-6K 2 telephone	AFD-6 6RJ T&B Omni jacks or Keystone style jacks	AFC-N grommeted closure panel
AFD-6A Single duplex		AFM-6EX extension collar

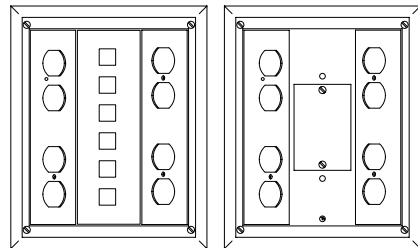

45° Angle Plates
Shown with supplied power panel and optional data panel and 45° power panel (sold separately).

60° Angle Plates
Shown with optional 60° panels (sold separately).

* (1) supplied with box

** Used to correct opening in floor. Not required for all installations.





AFM-6S Steel City Access Floor Module

Access Floor Module Size	AFM-6S
AFM Depth	2½"
Access Floor Cut-Out	7½" x 10"
AFM Cover Size	7½" x 9¾"
AFM Cover Access Area	60 sq in
Box Volume (Less Panels)	172 cu in
Device	45° Power — 60° Power —
Compartment	Center Data —
Volume	Power 13.1 cu in Data 6.6 cu in
Base Opening	—
Power Panel Included**	AFP-6S-L, AFP-6S-R
Closure Panel Included	—
Cover/Carpet Flange Material	Nylon-6
Body Material	14 ga galvanized steel
Prewiring Available	Yes*
Max. No. of Device Panels	▲

D

Steel City®





AFM	POWER PANELS
AFM-6S-BLK GRY BRN BGE	AFP-6S-R (L) single duplex (R-right side; L-left side) 
	AFP-6S-GR (-GL) single GFCI 
	AFP-6S-BR (-BL) blank 

* Special Panels Available — Consult Factory

** Devices not included

▲ 6 maximum (data only), 4 standard
(2 power, 2 data)

Available with black (-BLK), brown (-BRN), beige (-BGE), or gray (-GRY) cover flange.

DATA PANELS	ACCESSORIES
AFD-6S-2RJ T&B Omni jacks or Keystone style jacks 	AFR-6** mounting flange 
AFD-6S-IBM 1 IBM connector 	
AFD-6S-E 1 T&B Epitome module (short board only) 	AFD-6S-B Blank 

* (1) AFP-6S-R & (1) AFP-6S-L supplied with box

**Used to correct opening in floor. Not required for all installations.

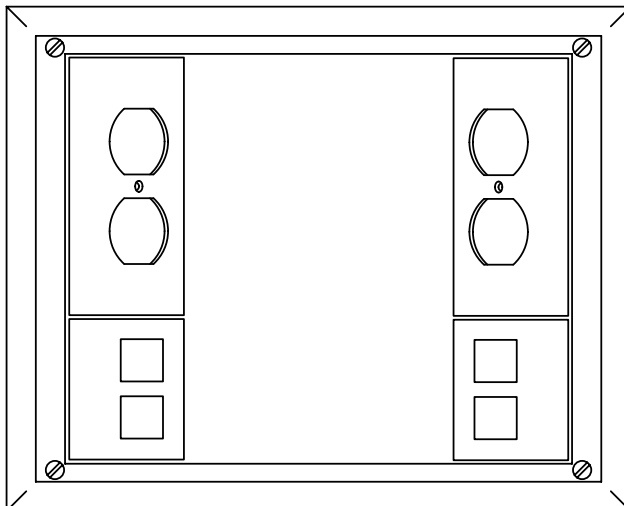

AFM-6S

Shown with supplied power panels and optional data panels (sold separately).

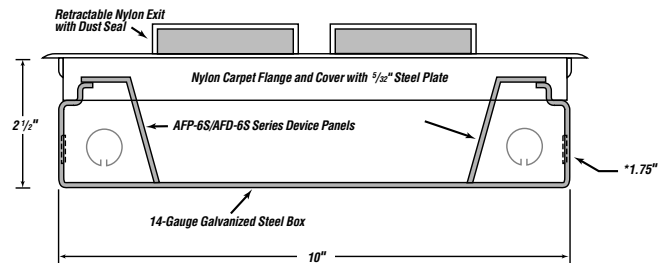



D

Steel City®





AFM-6V Access Floor Module



Access Floor Module Size	AFM-6V
AFM Depth	4.70"
Access Floor Cut-Out	7 ¹⁵ / ₁₆ " x 10"
AFM Cover Size	7 ⁵ / ₈ " x 9 ³ / ₄ "
AFM Cover Access Area	60 sq in
Box Volume (Less Panels)	201 cu in
Device	45° Power — 60° Power —
Compartment	Center Data —
Volume	Power 51 cu in Data 51 cu in
Base Opening	1.72" x 5.28"
Data Panel Included**	AFD-6V-2F
Power Panel Included**	AFP-6V-3D
Closure Panel Included	Yes
Cover/Carpet Flange Material	Nylon-6
Body Material	14 ga galvanized steel
Prewiring Available	Yes*
Max. No. of Device Panels	2

* Special Panels Available – Consult Factory

** Devices not included

Available with black (-BLK), brown (-BRN), beige (-BGE), or gray (-GRY) cover flange.

AFM	POWER PANELS
AFM-6V-BLK GRY BRN BGE	AFP-6V-3D* three duplex  AFP-6V-3G three GFCI 

DATA PANELS	ACCESSORIES
AFD-6V-2F* two single gang data face plates  AFD-6S-B blank 	AFR-6** mounting flange 

** (1) AFP-6V-3D & (1) AFD-6V-2F supplied with box.

** Used to correct opening in floor. Not required for all installations.

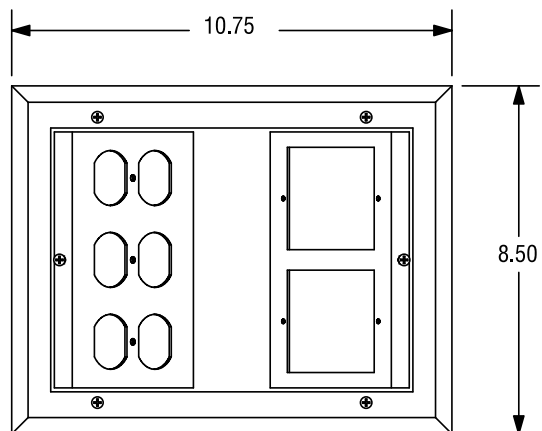
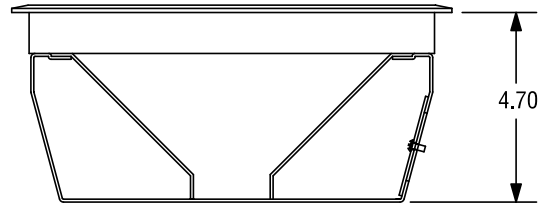

AFM-6V

Shown with supplied power panel and data panel.

Steel City®



Access Floor Modules





AFM-8 Access Floor Module

Access Floor Module Size	AFM-8
AFM Depth	5 5/8"
Access Floor Cut-Out	9 5/8" x 9 5/8"
AFM Cover Size	9 3/8" x 9 3/8"
AFM Cover Access Area	74 sq in
Box Volume (Less Panels)	325 cu in
Device	45° Power — 60° Power —
Compartment	Center Data —
Volume	Power 15.75 cu. in. Data 15.75 cu. in.
Base Opening	—
Power Panel Included*	—
Closure Panel Included	—
Cover/Carpet Flange Material	Nylon-6
Body Material	14 ga galvanized steel
Prewiring Available	Yes*
Max. No. of Device Panels	10

D
Steel City®

AFM	POWER PANELS
AFM-8-BLK GRY BRN BGE	AFP-8A single duplex  AFP-8G single GFCI  AFP-8B blank 

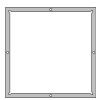
DATA PANELS	ACCESSORIES
AFD-8J 1 IBM set  AFD-8 3RJ Keystone 	AFR-8** Mounting Flange 

**Used to correct opening in floor. Not required for all installations.

†Not Shown

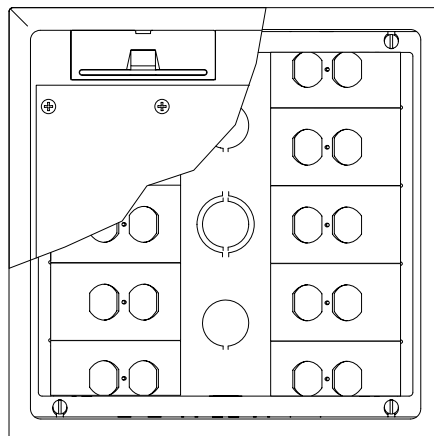
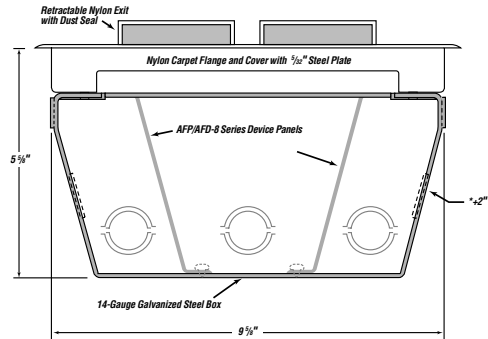

AFM-8
Shown with optional power panels
(sold separately).

Thomas & Betts

Steel City®

Access Floor Modules

For use with the AFM insert. The GAB cast Pre-Set includes center collar and styrene insert to prevent concrete ingress. Standard conduit hubs are 3/4" and 1 1/4". Specify either -4 or -6.

D

Steel City®

Base Presets*

Cat. No.	Dimensions			Maximum Capacity (cu. in.)	Standard Conduit Tapping	Maximum Conduit Tapping	AFM Insert	Std. Ctn.
	A	B	C					
GAB-4	4 1/4"	9"	16"	150	2 - 3/4" 2 - 1 1/4"	1 1/2"	AFM-4	1
GAB-6	4 1/4"	9"	16"	225	2 - 3/4" 2 - 1 1/4"	1 1/2"	AFM-6	1
GAB-8S	5 7/8"	9 3/4"	16 3/8"	325	2 - 3/4" 2 - 1 1/4"	-	AFM-8	1

*Required for installation in concrete pours only.

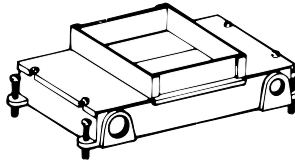

GAB-4
Cast Iron Base

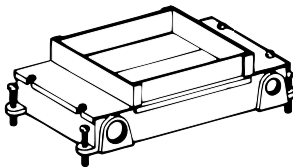

GAB-6
Cast Iron Base

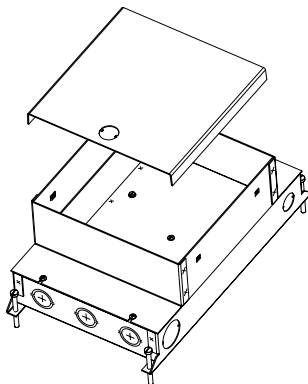

GAB-8S
Stamped Steel

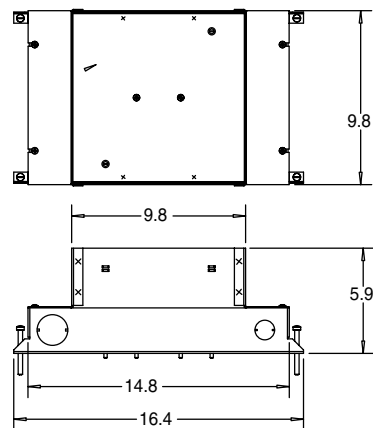
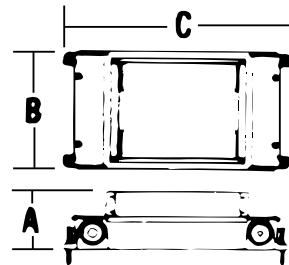

Standard Specification – GAB Series Access Floor Box Pre-Set Insert

Considerations when writing specification:

The installation of access floor box pre-set inserts must be in compliance with the National Electric Code. These specifications may be used in three sections of the Construction Specification Institute (C.S.I.) format: 16132 Floor Boxes; 16141 Wiring Devices; and 16741 Telephone Raceway Systems. For accuracy, 16132 is preferred.

PART 2: PRODUCTS

2.01 PRE-SET INSERT

- A. Shall be GAB Multiple Service Floor Outlet Assembly as manufactured by Thomas & Betts, Memphis, TN, (trade name, Steel City) consisting of:
1. Pre-set insert, Series GAB.
 2. Activating unit, Series AFM-4 and AFM-6.
- B. See Electrical Section for approved suppliers of power and cable systems.

2.02 MATERIALS

- A. Cast-iron components to be gray iron per ASTM Specification A48, Class 20A.
- B. Cast-iron components shall be protected with a painted coating as specified in U.L. 514A.
- C. Steel components to be fabricated from cold rolled steel, .070 inch minimum thickness, conforming to ASTM A366.
- D. Steel components to have an electrogalvanized zinc finish conforming to ASTM A386. Sheet metal steel fabrications shall be made of U.L. approved component G-90-U material.

- E. Nonmetallic components shall be glass-filled polyimide nylon, U.L. recognized component QMFZ2.

2.03 GENERAL DESIGN GAB SERIES

- A. The GAB series shall consist of pre-set insert, activation unit and cover for the distribution of electrical power and data/communication signal systems.

2.03.1 PRE-SET INSERT

- A. Following sizes as shown on the drawings:
1. 8" x 8" nominal concrete opening. (Ref.: Steel City GAB-4)
 2. 8" x 10" nominal concrete opening. (Ref.: Steel City GAB-6)
- B. Overall size:
8" x 14" x 4 $\frac{3}{16}$ " high.
- C. Shall be installed with conduit sizes as shown on the drawings. (Note: Standard $\frac{3}{4}$ " conduit thread on power side, in and out. Standard $1\frac{1}{4}$ " conduit thread on data side, in and out. Special drilling and tapping up to $1\frac{1}{2}$ " conduit size. Reducing bushings may be used to downsize conduit.)
- D. Conduits for power shall enter and leave in-line and on same side so as to maintain separation of services.
- E. Foam blocks shall exclude concrete from the interior.
1. Foam blocks shall permit a minimum of $1\frac{1}{4}$ " of concrete over opening prior to activation.
 2. Foam blocks shall be manufactured for the intended purpose.

2.03.2 ACTIVATION UNIT

- A. Following sizes shall match pre-set insert opening as shown on drawings.
1. 8" x 8" nominal size steel box (Ref.: Steel City AFM-4). Provides a minimum interior capacity of 150 cubic inches.
 2. 8" x 10" nominal size steel box (Ref.: Steel City AFM-6). Provides a minimum interior capacity of 225 cubic inches.

- B. Device panels may be data or telephone as shown on drawings.
- C. If two duplex power receptacles are required on a single panel, the pre-set insert and activation unit shall be Steel City GAB-6 and AFM-6 respectively.
- D. Data panels shall be designed to mount the data connectors and telephone connectors as shown on the drawings.
- E. Cover shall be (gray, brown, black or beige) as specified on the drawings.
1. Shall accept floor covering material as required.
 2. Shall be self-leveling when installed.
- F. Cover, when closed, shall protect exiting cables and cords from abuse and abrasion by retractable cable exits. Cover shall install flush with floor and be 180° reversible.
- G. Carpet edge shall be protected from fraying by a carpet trim ring of a matching color.

PART 3: EXECUTION

3.01 GENERAL

- A. All pre-set inserts shown on the drawings shall be installed with the specified runs of conduit.
- B. Wire-pulling cords shall be in place in the conduit prior to pouring concrete.
- C. Activate only the pre-set inserts as directed by the supervising engineer or owner.
- D. Install and activate the assembly as directed by the manufacturer's installation instructions.



Recessed Poke-Throughs



Thomas & Betts introduces the Recessed Poke-Through (RPT) series, the only poke-through to provide “recessed” power and communication services. These poke-through devices provide the complete protection of receptacles and jacks from impact and abuse. Available in three configurations: quad power receptacle with two communication ports, duplex power with four tele/data ports and a communication poke-through device with six ports. The quad configuration is the only two circuit poke-through on the market, allowing greater flexibility for dedicated wiring needs. The attractive brass and aluminum covers provide unmatched good looks. The communication outlets permit an open architecture use with “keystone®” jack openings for your data needs.

RPT Series Floor Box

Features and Benefits:

- Available in three configurations.
 - Quad power with two tele/data ports.
 - Duplex power with four tele/data ports.
 - Six tele/data ports only no power.
 - Provides unparalleled flexibility for Poke-Through fittings.
- Quad configuration comes standard with two 20-A circuits.
 - Only Poke-Through on the market with two circuit capacity.
 - Allows greater flexibility for dedicated wiring requirements.
 - Can be wired for isolated ground service.
- Available with metallic brass or aluminum covers.
 - Covers are 100% metallic –not metallic /plastic combination or plated plastic.
 - Provides unmatched aesthetics, durability and strength.
- Only Poke-Through in the industry to provide “recessed” service.
 - Greatly increases aesthetics of unit while not in use.
 - Provides additional protection of devices from dirt and debris.
 - Complete protection of devices and connectors from impact.
- Tele/data outlets punched for “keystone®” configuration.
- Base unit utilizes “One- Step” activation method.
 - Provides tremendous labor savings at installation.
 - Temporary cover allows installation early in construction phase with finish cover assembly to follow after carpet installation.
- Devices are pre-wired at the factory.
 - Eliminates additional wiring by the installer.
- Junction box factory assembled to 6" long ½" EMT conduit.
 - Conduit can easily be changed for different slab depths.
 - Junction box is supplied with 5½" & 5¾" ko's.
- Bottom of base unit threaded for conduit on low voltage side.
 - 1" conduit can easily be added for low voltage applications where local codes require or security is necessary.
- Base unit provides up to 2 hour fire rating in concrete on deck and concrete slab floors.
- 4" core drill required.

Recessed Poke-Through System

Dimensions

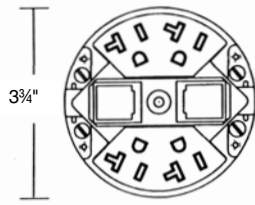

RPT-4P-2RJ
Without Cover



RPT-6RJ
Without Cover



RPT-2P-4RJ
Without Cover

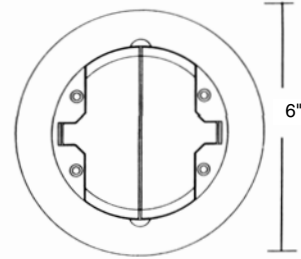

RPT-BRS
RPT-AL

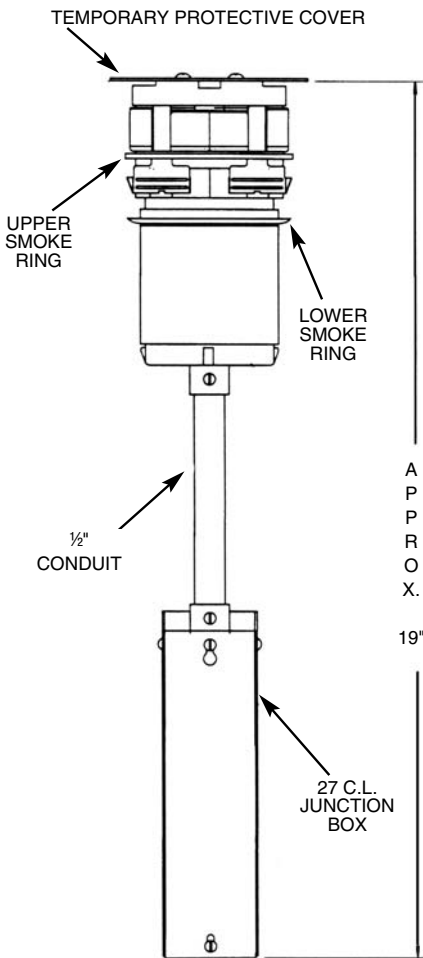

Knockouts:
 (2) 1/2" + (1) 3/4"- 2 sides
 (1) 1/2" + (2) 3/4"- back
 (1) 3/4"- bottom

Recessed Poke-Through Ordering Information

Cat. No.	Cover Description	Finish	Std. Ctn.
Two Circuit w./four 20A receptacles (two devices on each circuit) & two communication outlets.			
RPT-4P2RJ-BRS	Recessed Poke-Through Assembly	Solid Brass	1
RPT-4P2RJ-AL	Recessed Poke-Through Assembly	Aluminum	1
RPT-4 P2RJ	Recessed Poke-Through Activation	No Cover	1
RPT-4P2RJ-IG	Recessed Poke-Through Activation with Isolated Ground Receptacles	No Cover	1
Single circuit w./two 20A receptacles & four communication ports			
RPT-2P4RJ-BRS	Recessed Poke-Through Assembly	Solid Brass	1
RPT-2P4RJ-AL	Receded Poke-Through Assembly	Aluminum	1
RPT-2P4RJ	Recessed Poke-Through Activation	No Cover	1
RPT-2P4RJ-IG	Recessed Poke-Through Activation with Isolated Ground Receptacles	No Cover	1
Six data ports			
RPT-6RJ	Recessed Poke-Through Assembly	Finish Flange	1
RPT-6RJ-BRS	Recessed Poke-Through Assembly	Solid Brass	1
RPT-6RJ-AL	Recessed Poke-Through Assembly	Aluminum	1
Finish Flange			
RPT-BRS	Cover & Flange	Solid Brass	4
RPT-AL	Cover & Flange	Aluminum	4



Steel City®

Modular Poke-Through System

D

Steel City®



More Options Means The T&B Steel City® Poke-Through System Fits In Everywhere Today. And Tomorrow.

With more materials, colors, and port combinations to choose from, the T&B Steel City® Poke-Through System gives you the flexibility you need to meet the demands of changing office environments now and in the future. Our Poke-Through accepts both flush-profile covers and above-floor assemblies. The Steel City® Poke-Through's design also makes retrofitting a snap.

Choose from a wide variety of metallic and nonmetallic covers and service head fittings to perfectly suit your particular application. Whether using a pre-wired power version or a combination service fitting, the Steel City® Poke-Through System will make installation quick and easy and offer the maximum flexibility to adapt to your changing needs.

Features Of The T&B Steel City® Poke-Through System.

- Stainless steel retaining clips prevent rotating, loosening and backing out of lower unit.
- Factory assembled junction box allows "drop-in" installation, significantly reducing labor and installation time.
- 27 cu. in. junction box capacity allows up to 12 #12 AWG conductors.
- Junction box designed with five 1/2" and five 3/4" KOs provide flexibility when installing lower unit. Bottom 3/4" KO allows field adaptability to any floor thickness with use of standard conduit and fittings.
- Low voltage channel equivalent to 1 1/4" conduit capacity provide the largest capacity for low voltage cables in the industry. Low voltage channel will accept up to one 50 pair, 24 AWG cable.
- Elastomer ring provides cold smoke protection at installation.
- Universal mounting system unit allows changes to service fittings without removing lower unit.
- Nonmetallic flush covers available in five designer colors. Furnished with duplex flip lids and three data ports.
- Nonmetallic furniture feed covers provided with two 1/2" and one 3/4" tapped hub and fittings. Available in five designer colors.
- Metallic flush covers available in brushed aluminum and polished brass. Furnished with locking flip lids for use with with power or voice/data devices.
- Low profile Designer Series service fittings (DLP- Series) available in single and double power configurations along with combinations providing both power and communications. Available in gray, ivory or beige.
- Built-in slide covers (DLP- Series) protect and enhance the pedestal's appearance while opening easily.
- Communication compartment lid flips open when in use and close when not in use (DLP- covers only).
- Standard metallic service fittings made from cast aluminum with a brushed aluminum finish. Available in single, two and four gang configurations.
- Brushed aluminum face plates face plates are ordered separately, allowing customization for particular applications. See reverse for full description of available service plates.
- The Steel City® Poke-Through is fully U.L. listed and classified for one to four hour rated floors. The intumescent fire-retardant material expands up to seven times its volume to close power and data raceways in case of fire.

Thomas & Betts

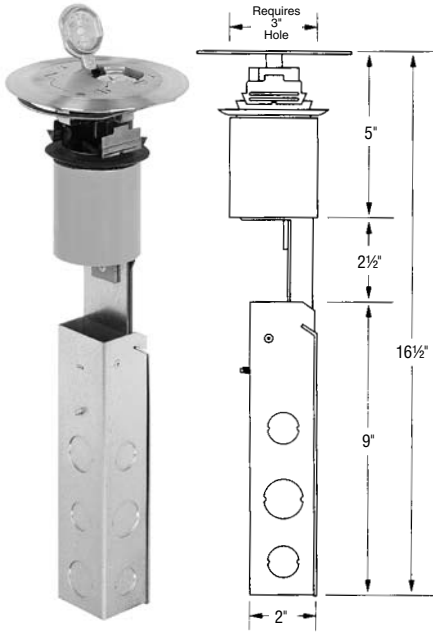

FPT-400B

FPT Poke-Through System Components

Cat. No.	Description	Std. Ctn.
Poke-Through Units with Covers		
FPT445-BRS	Base with FPT441-BRS cover; prewired 20A duplex recept.	1
FPT445-GRY	Base with FPT441-GRY cover; prewired 20A duplex recept.	1
FPT445-BRN	Base with FPT441-BRN cover; prewired 20A duplex recept.	1
FPT445-BLK	Base with FPT441-BLK cover; prewired 20A duplex recept.	1
FPT445-IVY	Base with FPT441-IVY cover; prewired 20A duplex recept.	1
FPT448-BRS	Base with FPT442-BRS cover	1
FPT448-GRY	Base with FPT442-GRY cover	1
FPT448-BRN	Base with FPT442-BRN cover	1
FPT448-BLK	Base with FPT442-BLK cover	1
FPT448-IVY	Base with FPT442-IVY cover	1
FPT449	Base with FPT-CACP cover; prewired 20A duplex recept.	1
FPT450	Base with FPT-CACP-AL cover; prewired 20A duplex recept.	1
FPT-H6-CRT*	6-Circuit Furniture Whip Poke-Through with aluminum cover	1

* Cover includes 3/4" and 1" KO for power and data respectively. Junction box has abundant room for splicing (71.5 cu. in.). For use in 3"-6" thick concrete slab or 1 1/2"-3" concrete topped steel deck.



FPT-H6-CRT

FPT Poke-Through Base Units

Cat. No.	Description	Std. Ctn.
FPT400B	Base Unit only for 3" Core	1
FPT400-DATA	Base unit for low voltage only (no junction box)	1



FPT400-DATA

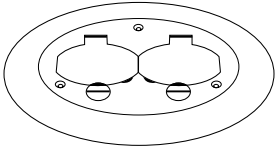

FPT-CACP
FPT-CACP-AL
Metallic Covers
5¾" Dia.

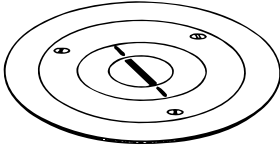

FPT-3/4-2-CACP
Metallic Covers
5¾" Dia.

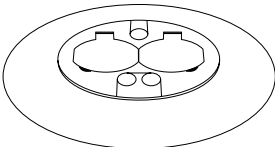

FPT441 Series
Nonmetallic Covers
7" Dia.

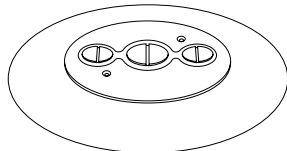

FPT442 Series
Nonmetallic Covers
(Two ½" Hubs & One ¾" Hub)
7" Dia.

Nonmetallic Covers for FPT Poke-Through

Cat. No.	Description	Std. Ctn.
FPT-CACP	Brass Metallic Flush Cover –Duplex	10
FPT-CACP-AL	Aluminum Metallic Flush Cover –Duplex	10
FPT-3/4-2-CACP	Brass Metallic Cover with ¾" and 2" plugs	10
FPT442	Aluminum Metallic Flush Cover with (1) 1" K.O. and (1) ¾" K.O.	10

Nonmetallic Covers for FPT Poke-Through

Cat. No.	Description	Std. Ctn.
FPT441-BRS	Brass Color Nonmetallic Flush Cover–Duplex, Data Ports	10
FPT441-GRY	Gray Color Nonmetallic Flush Cover–Duplex, Data Ports	10
FPT441-BRN	Brown Color Nonmetallic Flush Cover–Duplex, Data Ports	10
FPT441-BLK	Black Color Nonmetallic Flush Cover–Duplex, Data Ports	10
FPT441-IVY	Ivory Color Nonmetallic Flush Cover–Duplex, Data Ports	10
FPT442-BRS	Brass Color Nonmetallic Flush Cover–Conduit Cover	10
FPT442-GRY	Gray Color Nonmetallic Flush Cover–Conduit Cover	10
FPT442-BRN	Brown Color Nonmetallic Flush Cover–Conduit Cover	10
FPT442-BLK	Black Color Nonmetallic Flush Cover–Conduit Cover	10
FPT442-IVY	Ivory Color Nonmetallic Flush Cover–Conduit Cover	10

FPT Poke-Through Accessories

Cat. No.	Description	Std. Ctn.
FPT410A	Abandonment Plug for 3" Holes	1
FPT415	Temporary Abandonment Kits for Base Units	10

Above-Floor Service Fittings

Cat. No.	Description	Std. Ctn.
FPT401A	Single Unit – accepts two face plates	10
FPT421	Double Unit – accepts four face plates	5
FPT430	Quad Unit – accepts eight face plates	1

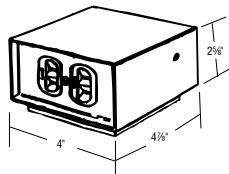

FPT401A
(Shown with FPT 424 Faceplate)

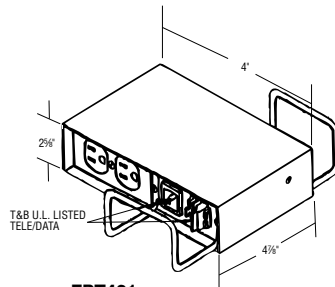

FPT421

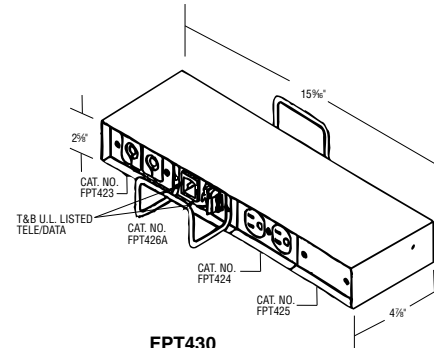

FPT430

Faceplates for Service Fittings

Cat. No.	Description	Std. Ctn.
FPT423	Communication Faceplate	50
FPT424	Power, Std. Duplex Faceplate	50
FPT425	Blank Faceplate	50
FPT426	Combination Faceplate – token ring data and voice	10
FPT427	Radiator kit for 50PR Telephone Cable	10
FPT428	Single Jack Faceplate	50
FPT429	Double Jack Faceplate	50

Accessories for Service Fittings

Cat. No.	Description	Std. Ctn.
FPT408A	Low Voltage Separator – single unit	10
FPT422A	Low Voltage Separator – double unit	10
FPT416	Adapter for conduit stub ups	50
FPT410A	Abandonment Plug fits 3" holes	1
FPT415	Temporary abandonment kits for lower units	10

Standard Specification – FPT Poke-Through

Service Fitting Fire-Rated

Considerations when writing specifications:

Fire-rated poke-through service fittings are special purpose devices that are furnished as an integral unit, consisting of a service fitting, poke-through device and an outlet box. They are classified for fire resistance by Underwriters Laboratories when installed in accordance with installation instructions provided with the product. When properly classified and used, they will not reduce the fire rating of concrete or steel and concrete floors that have fire resistance ratings as classified by the Fire Resistance Directory of Underwriters Laboratories. Poke-through service fittings provide service for both power and telephone (data) needs. As such, they may appear in your specifications as a power service fitting, telephone service fitting or floor box. The Construction Specifications Institute (CSI) reference three sections; Section 16141 Wiring Devices, Part 2, 2.05 and 2.06; Section 16741 Telephone Raceway System, Part 2, 1.012 G; Section 16132 Floor Boxes, Part 2. The preferred is Section 16141 Wiring Devices.

PART 2: PRODUCTS

2.05 ACCEPTABLE MANUFACTURERS—FIRE- RATED, POKE-THROUGH SERVICE FITTINGS.

A. Shall be the Poke-Through series as offered by Thomas & Betts—Catalog FPT Series.

2.06 GENERAL DESIGN—FIRE RATED, POKE-THROUGH SERVICE FITTINGS.

- A. Shall be U.L. classified for use in up to four hour rated concrete floors, and up to three hour rated steel and concrete floors.
- B. Shall be U.L. listed for use with power and telephone (data) in a single service fitting and shall protect against ingress of water or foreign material with a neoprene gasket at base of fitting.
- C. Shall be installed in a single 3" core drilled hole.
- D. Shall be self-locking type insert such that no screws are used to secure device in hole.
- E. Shall permit use with "H" cut opening in carpet so carpet can be restored if position is vacated.

- F. Shall have interchangeable service fitting accessories including hinged guard and IBM cabling data support.
- G. Service fitting head shall be as specified.
- H. Shall accept one 100 pair, one 50 pair, or two 25 pair cables with space to insert an uncoupled 25 pair amphenol connector through communication raceway.
- I. Shall accept 12 No. 12 AWG power conductors.

PART 3: EXECUTION

3.01 INSTALLATION

A. Core drill openings for poke-through service fitting and install in accordance with manufacturers instructions.

Note: minimum spacing of 2 feet on center and not more than one unit per each 65 square feet of floor area in each span. Required by Fire Resistance Directory.

Standard Specification- RPT Poke Through

PART 1: Consideration when writing specifications

Fire-rated poke-through service fittings are special purpose devices that are furnished as an integral unit, consisting of a service fitting, poke-through device and an outlet box. They are classified for fire resistance by Underwriters Laboratories, Inc. when installed in accordance with installation instructions provided with the product. When properly classified and used, they will not reduce the fire rating of concrete or steel and concrete floors that have fire resistance ratings as classified by the Fire Resistance Directory of Underwriters Laboratories. Poke-through service fittings provide service for both power and communication cabling needs. As such, they may appear in your specifications as power service fittings, telephone service fitting or floor box.

The Construction Specifications Institute (CSI) references three sections:

Section 16141 Wiring Devices, Part 2, 2.05 and 2.06

Section 16741 Telephone Raceway System, Part 2, 2.012 G

Section 16132 Floor Boxes, Part 2

PART 2: PRODUCT

2.1 MANUFACTURER

The poke-through devices specified herein shall be the Recessed Poke-Through Devices (RPT Series) as manufactured by the Thomas & Betts Corporation. Systems of other manufacturers may be considered equal if, in the opinion, and the written approval of the engineer, meet all the performance standards specified herein.

2.2 MATERIALS

2.2.1 Poke-through service fittings shall be UL classified for use in up to a two-hour fire rating in concrete on steel deck and concrete slab floors. The poke-through service fittings shall be UL listed for use with power and communication (telephone and data) services in a single fitting.

2.2.2 Shall provide "recessed" service for power outlets and communication jacks with protective solid brass or anodized aluminum covers. The device shall be installed in a single four inch (4") core drilled hole by means of a self-locking type insert such that no screws are used to secure the device in the hole.

2.2.3 The "Quad" version double duplex style shall be wired with two 20A 120V circuits. The device shall have six #12 THHN conductors, capable of being wired for dedicated isolated ground services as needed.

2.2.4 Base unit shall be threaded for 1/2" conduit one the power side and 1" conduit on the low voltage side, enabling the conduit length to be changed for different slab depths.

2.2.5 All units must be capable of mounting Thomas & Betts Omni 110 style jacks and/or keystone-style jacks in a single housing. Additional communication adapters forcoaxial, ST and SC fiber, and F connectors must be available.

PART 3 - EXECUTION

3.1 INSTALLATION

Core-drill openings for poke-through service fittings and install in accordance with manufacturer's instructions. Note: minimum spacing of 2 feet on center and not more than one unit per each 65 square feet of floor are in each span, required by Fire Resistance Directory.