

## Phase Adaptive Power Module

The DIN Power Module (DPM) family is a group of modular products for the control of lighting loads. This document describes the following product:

LQSE-4A-120-D: 4-Zone DIN Power Module for Dimming lighting loads

### Features

- Phase Adaptive Power Modules can be used in a HomeWorks QS system.
- Includes QS link for seamless integration of lights and controls.
- An auto-detect mode is available to detect and configure leading-edge or trailing-edge dimming for incandescent/halogen, electronic/magnetic low-voltage and neon/cold cathode light sources.
- Controls dimmable CFL/LED loads. Refer to [www.lutron.com/ledtool](http://www.lutron.com/ledtool) or App Note #478 (048478) for compatibility with dimmable CFL/LED light sources.
- SSL7 compliant for compatibility with solid state lighting.
- RTISS Equipped technology compensates for incoming line-voltage variations (up to  $\pm 2\%$  change in frequency/second) such as changes in Root Mean Square (RMS) voltage, frequency shifts, harmonics and line noise.
- RTISS-TE operates on the trailing edge of the AC sine wave. This allows for true instantaneous voltage compensation.
- Provides air gap off (when all zones are off).
- Integral protection for common temporary over-current and over-voltage conditions.
- LEDs on the module provide diagnostic information.
- Buttons on the module provide override control.
- Manual Override contact closure input (CCI).
- Power failure memory automatically returns the outputs to the levels they were set to prior to a power outage.

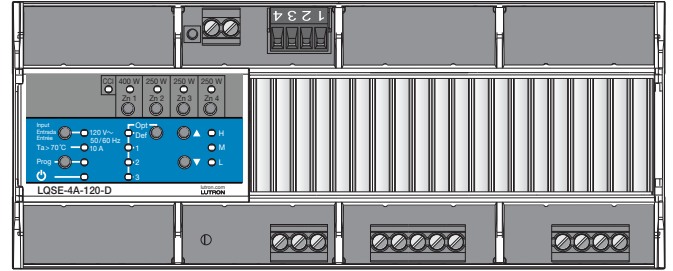

LQSE-4A-120-D

Job Name:	Model Numbers:
Job Number:	

System Example

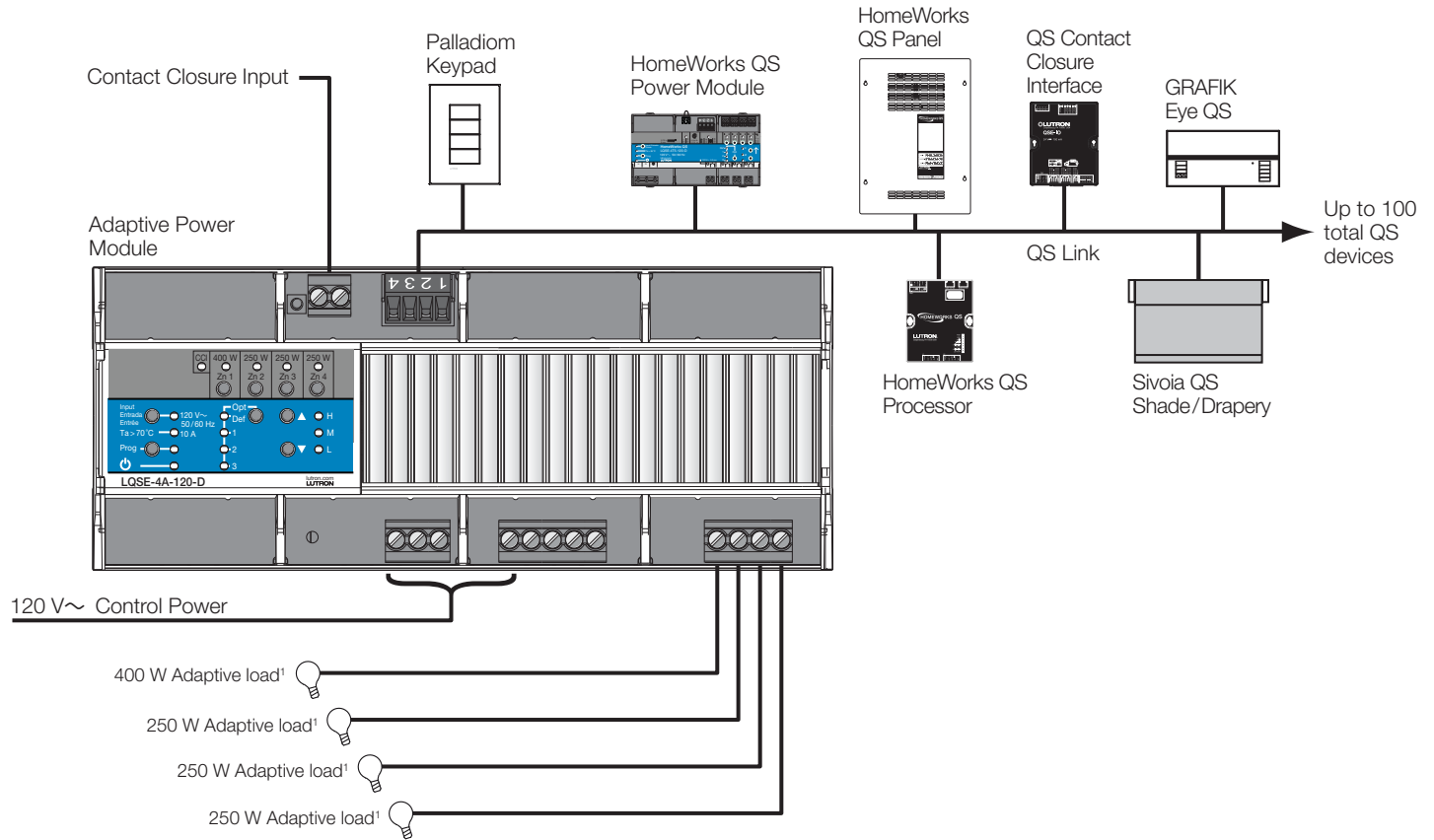

Notes:

<sup>1</sup> See "Output Zone Ratings" in "Specifications" section, for specific load types ratings.

Job Name:	Model Numbers:
Job Number:	

# Specifications

## Adaptive Power Module

### Power

- 120 V~ 50/60 Hz
- 10 A maximum total input current
- Lightning strike protection meets ANSI/IEEE standard 62.31-1980. Can withstand voltage surges of up to 6000 V and current surges of up to 3000 A.
- Contact Lutron for ungrounded delta feed applications.

### Regulatory Approvals

- Lutron Quality Systems registered to ISO 9001.2015
- cULus® Listed
- NOM Certified
- SSL7A-2015

### Environment

- See **Mounting** on page 4 for thermal specifications.
- Relative humidity: less than 90% non-condensing
- For indoor use only.

### Output Zone Ratings

- Each zone has no minimum load requirement.
- When programmed to "auto" mode, the unit starts in trailing-edge and if an incompatible load is detected, it will convert to leading-edge.
- Internal relay provides an air gap off when all zones are off.
- One load type per zone.
- Output must not be used to control receptacles.
- If controlling plug-in lamps, installation must ensure a method of preventing non-rated loads being plugged into the unit. An example is a dedicated receptacle with an alternate plug load such as a Duplex Dimming Receptacle (NTR-15-DFDU-) and Dimming Lamp Plug (RP-FDU-10-).
- Does not support non-dimmable loads.
- Output must be directly connected to the load.
- Output breakers or switches must not be used.
- Run a separate neutral for each load circuit. A common neutral connection is not recommended.
- Unit may be powered by Ground Fault Circuit Interrupter (GFCI) or Arc Fault Circuit Interrupter (AFCI) if required. If using a GFCI or an AFCI incorporating GFCI protection, maximum wire length between the power module and the load must be less than 100 ft (30 m). Load circuit wiring (from breaker to unit to load) must be run in its own non-metallic conduit, or nuisance tripping may occur.
- For applications requiring 0–10 V<sub>DC</sub> control, use Ten Volt Interface (GRX-TVI) or the LQSE-4T5-120-D.
- For applications requiring higher wattage ratings, use a power booster (PHPM-PA-120-WH).
- For applications requiring switching control, use a PHPM-SW-DV-WH interface or the LQSE-4S8-120-D.

<p>Job Name:</p>  <p>Job Number:</p>	<p>Model Numbers:</p>
--	-----------------------

## Specifications *(continued)*

### Output Zone Ratings *(continued)*

- **No Derating** is required if all the conditions below are met:
  - Calibration point maximum is 158 °F (70 °C)
  - Room ambient temperature is between 32 °F and 86 °F (0 °C and 30 °C)
  - Panel ambient temperature is between 32 °F and 122 °F (0 °C and 50 °C)
- **50 W Derating** is required on all zones for a single module in a single non-ventilated DIN enclosure if:
  - The room ambient temperature is between 86 °F and 104 °F (30 °C and 40 °C)
- **100 W Derating** is required on all zones for multiple row non-ventilated DIN enclosure if:
  - The room ambient temperature is between 86 °F and 104 °F (30 °C and 40 °C)

Each zone is rated for the following wattage and load types<sup>A, B:</sup>

Load Type	Zone 1 Rating			Zone 2, 3 and 4 Rating (per zone)		
	No Derating	50 W Derating	100 W Derating	No Derating	50 W Derating	100 W Derating
LED <sup>B</sup>	2 A	2 A	2 A	2 A	2 A	2 A
Hi-lume A-series LTE <sup>F</sup>	2 A (6 drivers maximum)	2 A (6 drivers maximum)	2 A (6 drivers maximum)	2 A (6 drivers maximum)	2 A (6 drivers maximum)	2 A (6 drivers maximum)
SSL7A-2015 <sup>F</sup>	100 W	100 W	100 W	100 W	100 W	100 W
Incandescent/Halogen, ELV	400 W	350 W	300 W	250 W	200 W	150 W
Neon/Cold Cathode, MLV <sup>D</sup>	400 VA (300 W <sup>C</sup> )	350 VA (260 W <sup>C</sup> )	300 VA (225 W <sup>C</sup> )	250 VA (190 W <sup>C</sup> )	200 VA (150 W <sup>C</sup> )	150 VA (110 W <sup>C</sup> )

<sup>A</sup> Additional load type options are available in the HomeWorks QS software suite, some may require an interface. Contact Lutron for details.  
<sup>B</sup> Refer to [www.lutron.com/ledtool](http://www.lutron.com/ledtool) or App note #478 (048478) for specific LED compatibility information and recommended LED light sources.  
<sup>C</sup> Actual lamp wattage.  
<sup>D</sup> Only use iron core transformers intended for use with an electronic switch or dimmer per Clause 8.3 of IEC/EN 60669-2-1  
<sup>E</sup> Complies with SSL7A-2015 when configured in the HomeWorks QS software suite to LED forward phase with low-end trim set to 10% and high-end trim set to 90%.  
<sup>F</sup> Load type must be set to "Hi-lume 1% 2-Wire LTE LED", with low-end trim = 32% and high-end trim = 78%. Setting the proper trim and load type is necessary to ensure optimal performance and 1% dimming capability.

<b>Job Name:</b>  <b>Job Number:</b>	<b>Model Numbers:</b>
--	-----------------------

### Specifications (continued)

#### Terminals (Torque, wire gauge & type ratings)

- Mains wiring: 5 in-lbs (0.6 N•m)  
16 AWG to 10 AWG (1.0 mm<sup>2</sup> to 4.0 mm<sup>2</sup>)  
(single wire, solid or stranded)
- Zone wiring: 5 in-lbs (0.6 N•m)  
16 AWG to 10 AWG (1.0 mm<sup>2</sup> to 4.0 mm<sup>2</sup>)  
(single wire, solid or stranded)
- CCI wiring: 5 in-lbs (0.6 N•m)  
20 AWG to 10 AWG (0.5 mm<sup>2</sup> to 4.0 mm<sup>2</sup>)  
(single wire, solid or stranded)  
20 AWG to 16 AWG (0.5 mm<sup>2</sup> to 1.5 mm<sup>2</sup>)  
(two wires, solid or stranded)
- QS Link: 5 in-lbs (0.6 N•m)  
  
Power (terminals 1 and 2): 1 pair 18 AWG  
to 12 AWG (1.0 mm<sup>2</sup> to 4.0 mm<sup>2</sup>)  
  
Data (terminals 3 and 4): 1 pair 22 AWG  
(0.5 mm<sup>2</sup>), twisted and shielded

### Out of Box Functionality

This section describes the default functionality when the unit is first installed.

#### Manual Override Contact Closure Input (CCI)

- When the CCI is open, the unit will enter Manual Override Mode, which will turn on all loads to their manual override level and disable control of local zones and QS devices.
- When the CCI is closed or jumpered, zones will return to the settings or levels they were at prior to entering manual override mode.  
**Note:** Unit will process any sensor events received while in manual override mode after it exits manual override mode.

#### Normal Mode Operation

- By default each zone is set to an unassigned/Non-Dim load type. Each zone will switch load on or off until it is configured via unit programming. Once configured, the load type cannot be changed back to unassigned/Non-Dim.
- Zone and raise/lower buttons on the unit can be used to:
  - Turn loads on and off.
  - Dim loads up and down.

Job Name:	Model Numbers:
Job Number:	

## Mounting

- See Lutron P/N 048466 at [www.lutron.com](http://www.lutron.com) for more information on mounting and installation in panels with integrated DIN rail.
- Unit is 12 DIN modules wide, 8.5 in (216 mm).
- Mount in IP20 (minimum) rated consumer panel or breaker panel with integrated DIN rail.
- Mount unit in orientation shown.
- Mount to DIN rail by pressing unit onto rail with clips locked. To remove from rail, unlock clips using a screwdriver.
- Mount in an accessible and serviceable location.
- Unit generates heat, maximum 75 BTUs/Hour.
- Mount unit such that all the conditions below are met:
  - Room ambient temperature is between 32 °F and 86 °F (0 °C and 30 °C)
  - Temperature inside mounting panel, within 0.8 in (20 mm) of unit, is between 32 °F and 122 °F (0 °C and 50 °C)
  - Calibration point maximum: 158 °F (70 °C)

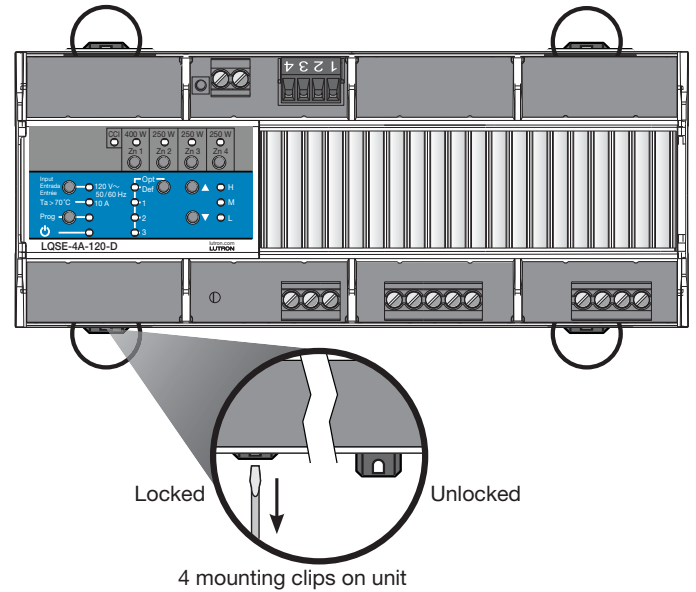

## Mechanical Dimensions

Left Side View

Front View

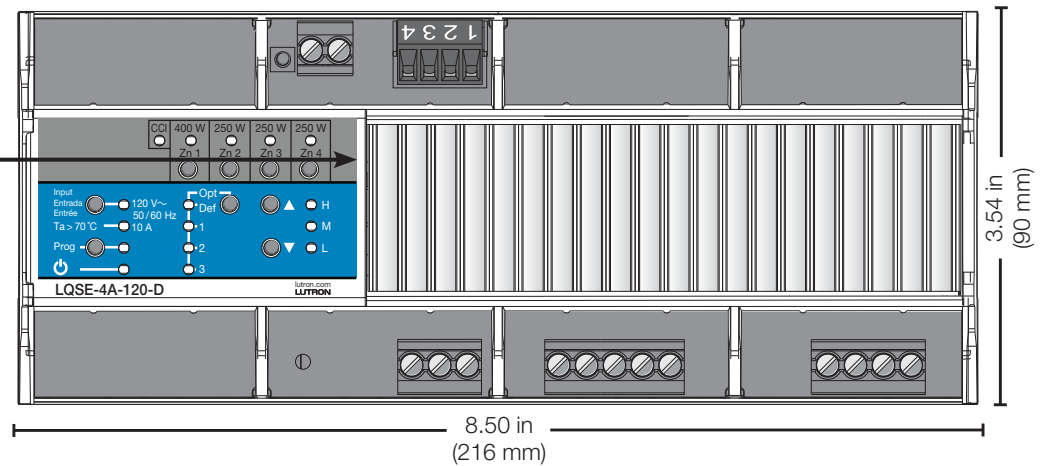
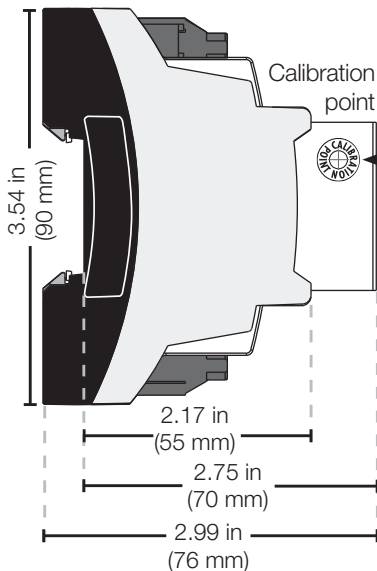

Job Name:	Model Numbers:
Job Number:	

# Overview of Wiring Terminals

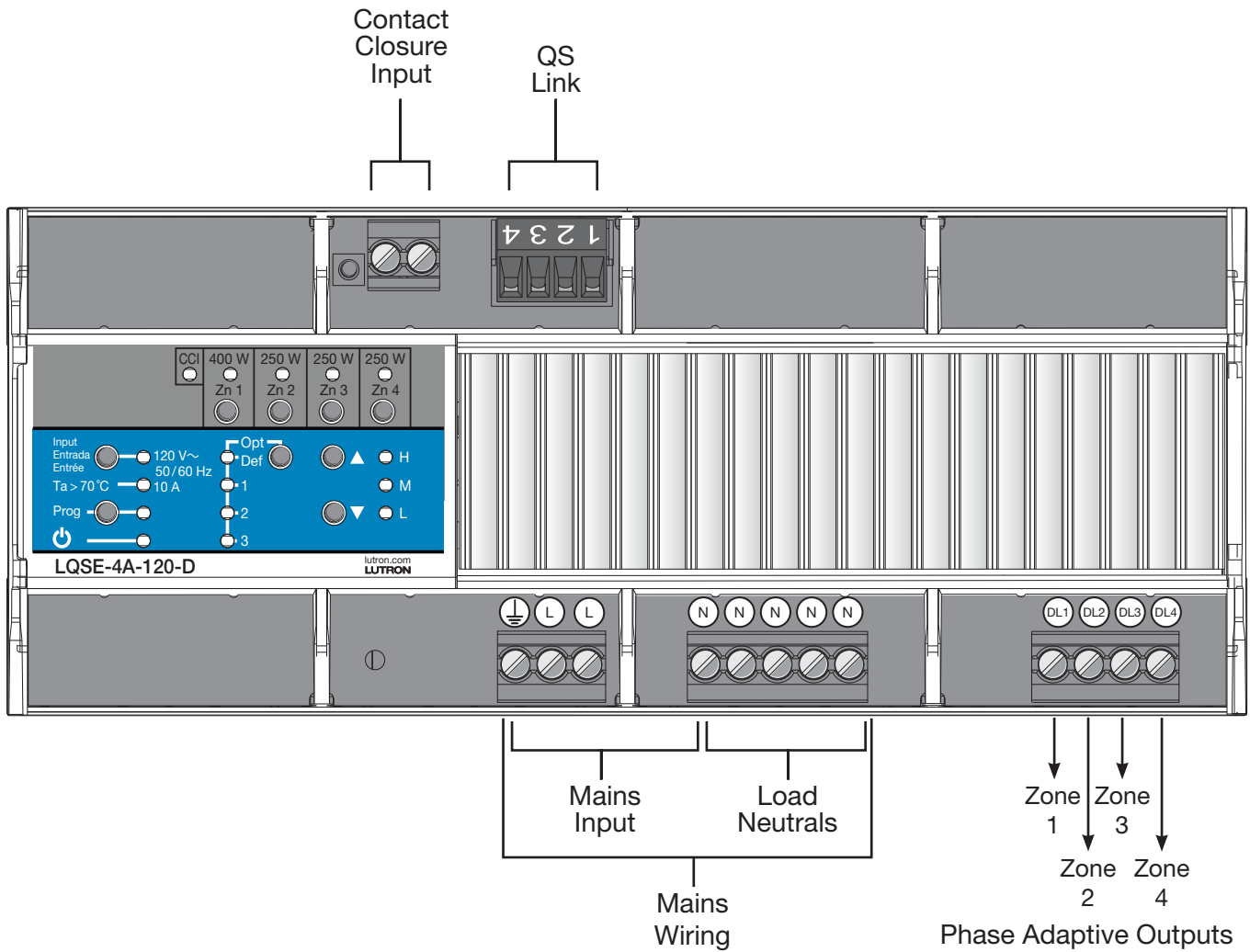

Job Name:	Model Numbers:
Job Number:	

### Verify Wiring

- Apply power to loads to identify any load or wiring faults prior to connecting loads to unit.
- To verify wiring:
  1. Turn off power.
  2. Connect loads directly to Hot to bypass the unit and protect it from wiring faults.
  3. Apply power, ensure the desired loads are powered and properly wired.
  4. Turn off power and connect loads to DL terminals on unit for normal operation.

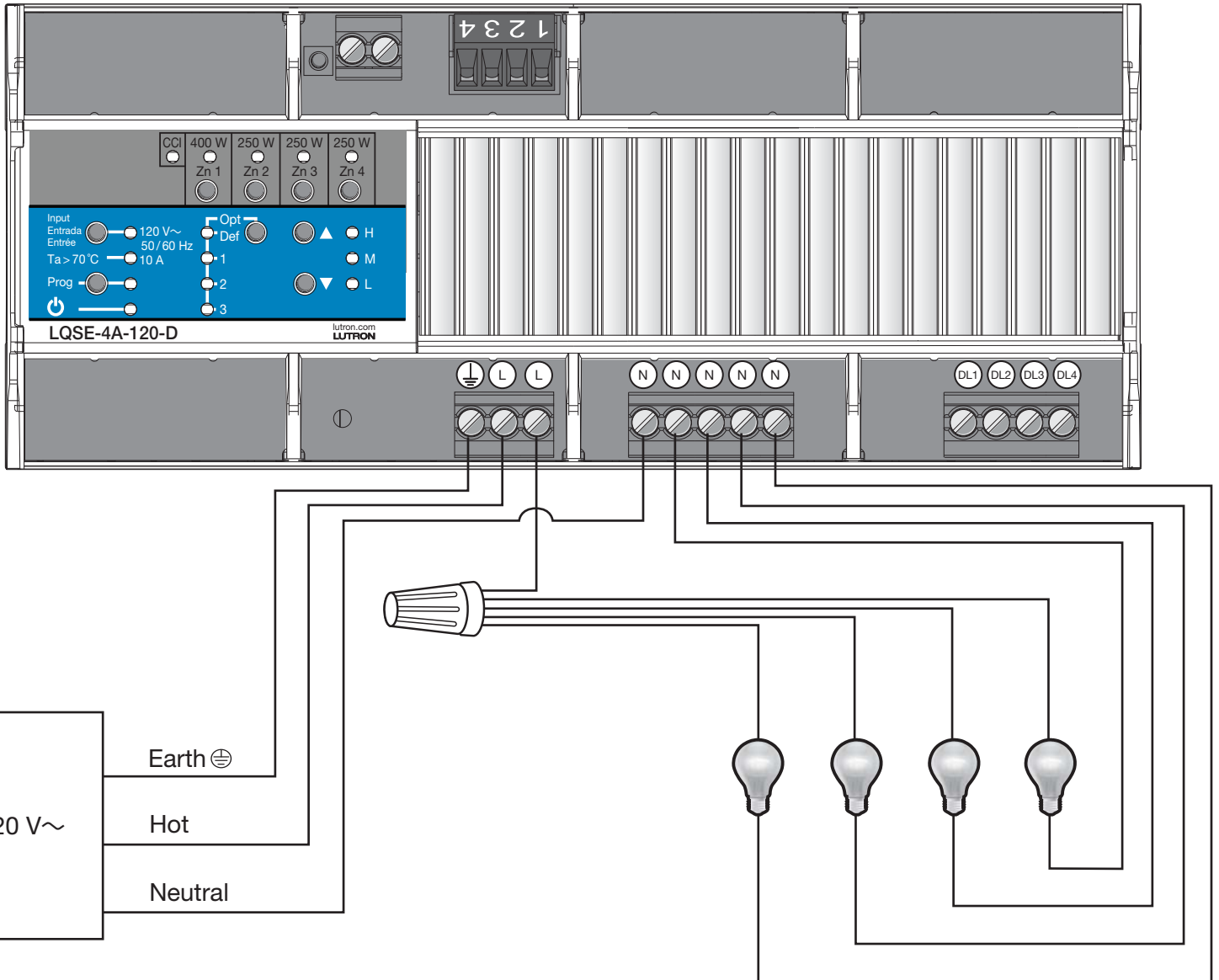

Job Name:	Model Numbers:
Job Number:	



### Mains Voltage Wiring

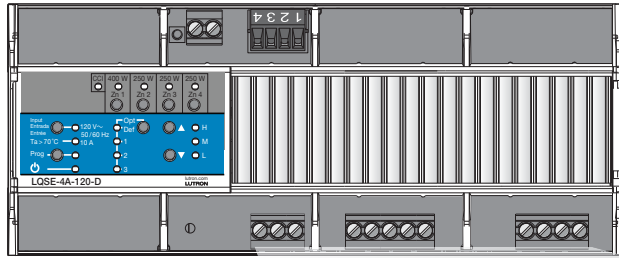

Zone 1 Example

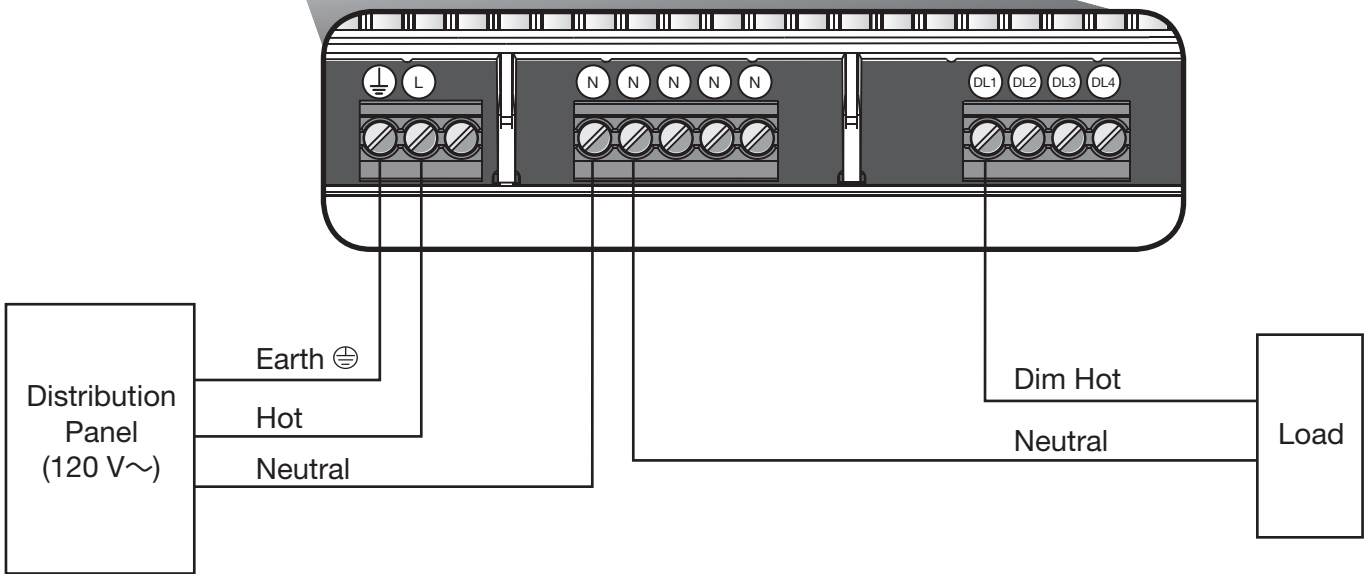

### Wiring from Distribution to Adaptive Power Module

- Turn off all circuit breakers or isolators feeding the Adaptive Power Module at distribution panel.
- Run hot, neutral, and earth (⊕) wires from a 120 V~ 50/60 Hz feed to the power module.
- Run a separate neutral for each load circuit.

### Mains Wiring and NEC® Class 2 Separation

- Follow appropriate local and national codes to ensure proper separation.

Job Name:	Model Numbers:
Job Number:	

### Wiring: Contact Closure Input

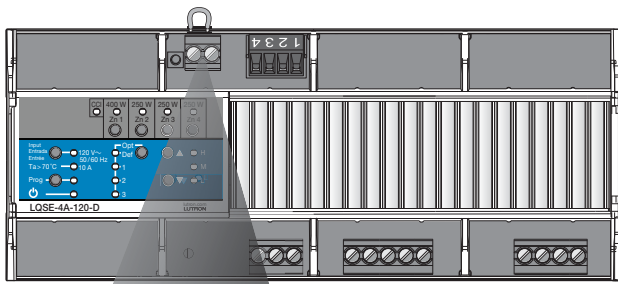

**Note:** Shown with pre-installed jumper.

### NEC® Class 2 Contact Closure Input

- Contact Closure Input (CCI) wiring is NEC® Class 2. Follow all applicable national and local codes for proper circuit separation and protection.
- Turn off all breakers or isolators feeding the unit at distribution panel before servicing unit.
- The CCI is a local control only and cannot control other units over the QS link. A maximum of 32 units may be connected in parallel to a Manual Override device if the event is intended to affect multiple devices.
- When in manual override mode, all zone outputs will be at their programmed emergency light level (configurable for each zone, default is 100%). All sensors and controls are locked out.
- Contact closure input is normally closed (NC). The unit is shipped with a jumper pre-installed.

**Note:** The unit will default to Manual Override Mode if the CCI is left open. If no Manual Override Contact Closure Input is required, leave the wire jumper in the CCI terminals.

Job Name:	Model Numbers:
Job Number:	

### Wiring: QS Link

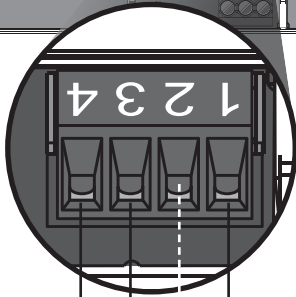
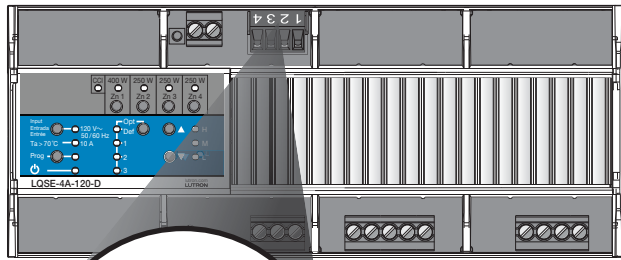

- (1) COM
- (2) Do Not Connect Terminal 2<sup>1</sup>
- (3) MUX
- (4) MUX

### QS Link NEC® Class 2 Wiring

- Follow all applicable national and local codes for proper circuit separation and protection.
- Link communicates using NEC® Class 2 wiring.
- Wiring may be daisy chained or t-tapped.
- Do NOT connect terminal 2.

### QS Link Wiring Options

Control Link Length	Wire Gauge (for terminals)	Available from Lutron in one cable:
Less than 500 ft (153 m)	Power (terminals 1 and 2): 1 pair 18 AWG (1.0 mm <sup>2</sup> )	GRX-CBL-346S
	Data (terminals 3 and 4): 1 pair 22 AWG (0.5 mm <sup>2</sup> ), twisted and shielded*	
500 ft (153 m) to 2000 ft (610 m)	Power (terminals 1 and 2): 1 pair 12 AWG (4.0 mm <sup>2</sup> )	GRX-CBL-46L
	Data (terminals 3 and 4): 1 pair 22 AWG (0.5 mm <sup>2</sup> ), twisted and shielded*	

### Daisy-Chain Wiring Example

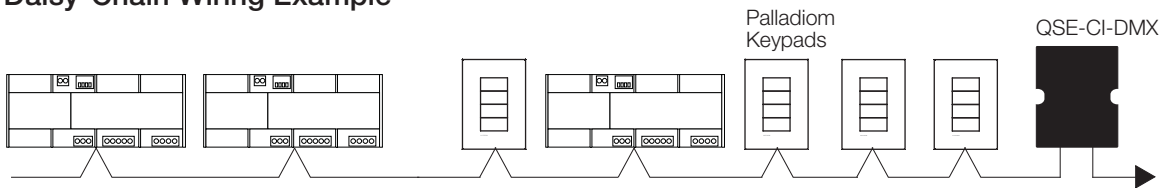

### T-Tap Wiring Example

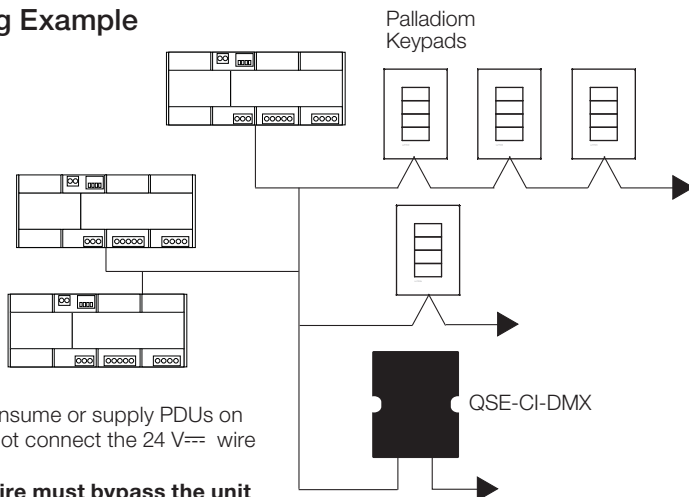

<sup>1</sup> Unit does not consume or supply PDUs on the QS link. Do not connect the 24 V<sub>DC</sub> wire to unit.

**Note: 24 V<sub>DC</sub> wire must bypass the unit if other devices on the link consume PDUs.**

©Lutron, Lutron, HomeWorks, RTISS Equipped, GRAFIK Eye, Palladiom, Hi-lume, Sivoia, and seeTouch are trademarks of Lutron Electronics Co., Inc. registered in the U.S. and other countries.

RTISS-TE is a trademark of Lutron Electronics Co., Inc.

UL is a trademark of UL LLC.

NEC is a registered trademark of National Fire Protection Association, Quincy, Massachusetts.

Job Name:	Model Numbers:
Job Number:	