

Surface Raceway and Lighting Support Systems

Surface Raceway and Lighting Support Systems

The Kindorf® Lighting Support System consists of high quality construction materials that afford definite installation advantages to those most concerned with lighting installations. When used as a Surface Metal Raceway it is UL Listed and complies with National Electrical Code Article 352.

A

To the Owner

A flexible installation requiring fewer attachments to the building structure with built-in provisions for easy maintenance and future modifications when lighting fixtures must be added, deleted or relocated. Kindorf® channel and fittings form a strong, economical and attractive support and wiring system for fixtures and other equipment.

To the Architect and Engineer

A system of construction least demanding on general design conditions and readily adaptable to all spacing of pillars, purlins and other structural components. Supply will not delay a job because Kindorf® channel is stocked at many locations throughout the country. The Kindorf® System saves planning time because it is designed for fast and easy installation by the contractor with little or no detailing.

To the Contractor

The Kindorf® System consists of time saving materials that will simultaneously provide for the electrical feed and the mechanical support of lighting and other equipment. Kindorf® affords a means of making fewer attachments to the structure at wider spacing. It insures true and rigid alignment and lends itself to systematic preassembly methods which economize on labor. No special tools for installation and no painting is required. Kindorf® speeds all jobs because a complete line of fittings assures easy solution of many installation problems as they arise in the field.

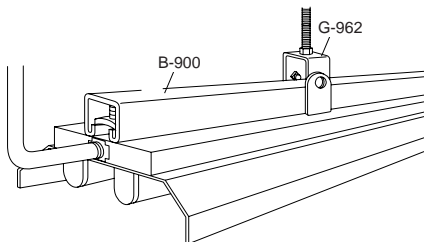

Channel raceway system supports and feeds fluorescent lighting fixtures.

Surface Raceway Channel Systems

A

Knock-out type by means of $\frac{1}{2}$ " channel knockouts on 6" centers

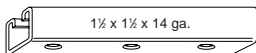

G-975-M

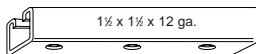

G-975

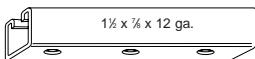

G-965



G-955



G-972-1/2
Nipple
Lock nut
and bushing



G-974-1-1/4

Plug-in type by means of sliding fixture hanger

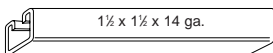

B-900-M

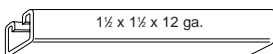

B-900

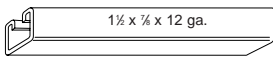

B-901

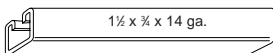

B-906

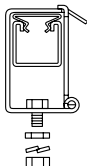

G-1012
Hanger with H-115-A bolt and
square nut plus
G-1016 and H-118-C washers

Electrical Conductors "Lay-In" the Channel

Kindorf® Surface Raceway channels provide a central wiring distribution system with conductor capacity that exceeds requirements of any lighting layout and with "power to spare" for other uses. Channel adapts to any interval of structural support — may be dropped to any level where it becomes a rigid platform for fixture attachment. Lighting fixtures may be spaced and fastened anywhere along the channel system with "plug-in" or direct feed electrical connection.

Branch lighting circuit conductors are completely enclosed in channel from panel to fixture eliminating the ordinary "clutter" of external conductors and protecting the wires from physical damage.

Listed by Underwriters Laboratories, Inc.

Surface Raceway and Lighting Support Systems

Channel Support Lighting Systems

Shoulder bolt type by means of special shoulder bolt $\frac{13}{32}$ " x 3" slots on 4" centers

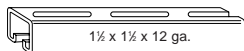

G-953

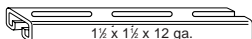

G-956

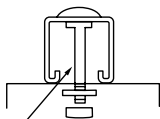

G-973-2-1/4

Spring-nut type by means of spring-nut and bolt combination

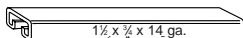

B-906

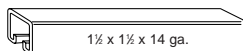

B-900-M

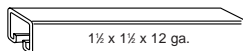

B-900

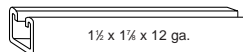

B-901

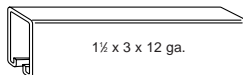

B-902

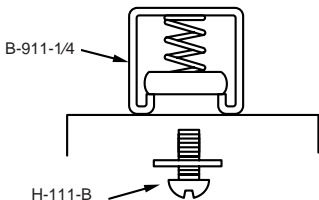

Kindorf® channels, installed slot-side down, are designed to provide fixture support only. A range of accessory fittings permit fixture attachment to the channel safely and securely in an approved manner. Channels with solid base or with slots are generally used for simple channel support systems.

Channel support systems combine economy of investment with maximum strength and rigidity. The continuous-slot channel provides complete flexibility of lighting layout with fixture spacing continuous or intermittent. Fixtures may be added or relocated to meet changing requirements without disturbing the basic support system. The rigid channels maintain fixture alignment, adapt to any interval of structural support.

Other Mechanical Details

A

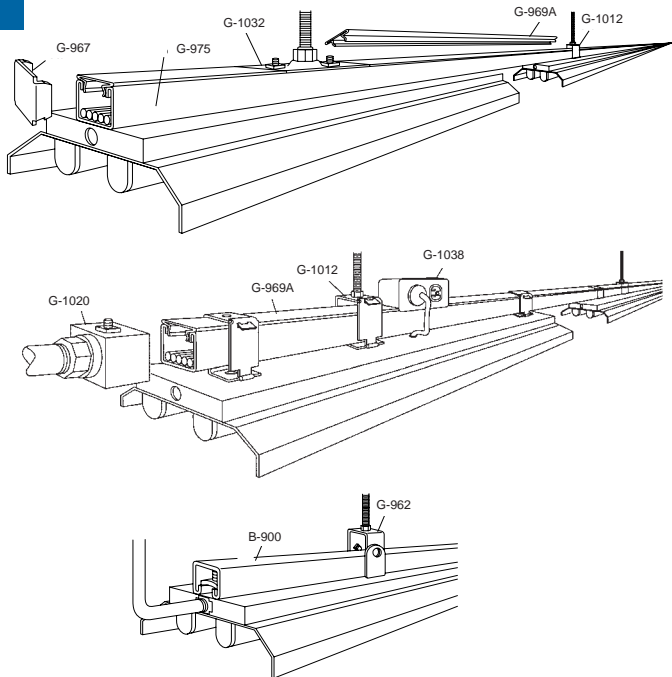

Surface Raceway and Lighting Support Systems

For Mounting or Suspending High-Intensity Lighting Fixtures in High Bay Installations.

A