



### TWO HOLE HYLUG™ CODE CONDUCTOR LONG BARREL WITH INSPECTION WINDOW

TYPES YAZ-2N, YAZ-2TC

UL LISTED 90° C,  
600 VOLT TO 35 KV ◆

C-54

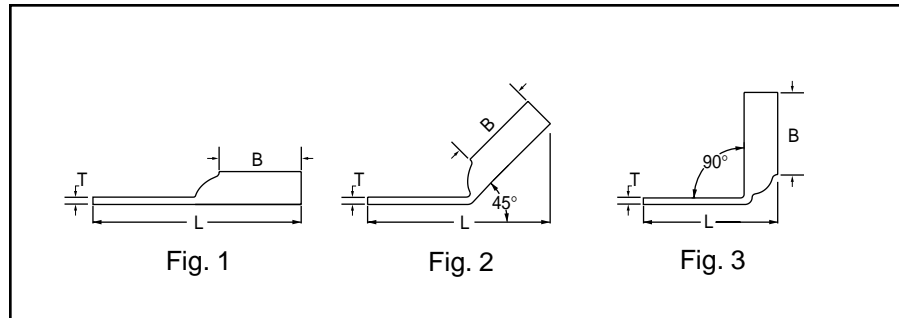
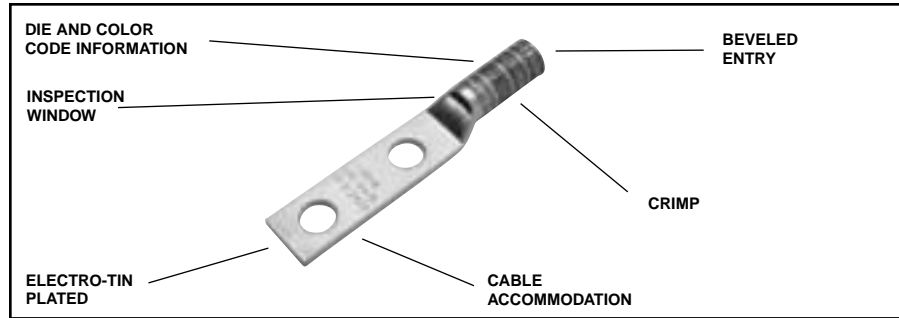

Catalog Number	Fig #	Conductor		Stud Hole Size	Stud Hole Spacing	Tongue Width	Figure Dimensions			Dieless (# of crimps)	▲ Installation Tooling				Wire Strip Length															
		AWG	MM <sup>2</sup>				(B)	(T)	(L)		Mechanical MD6, OUR840 MD7-34R	Hydraulic		Color Code		Die Index														
												BCT500HS Y500CTHS	Y35, Y39, Y750 Y46, BAT35, BAT750																	
YAZV10-2TC14	1	14-10 AWG	6	1/4"	5/8"	.41"	.69"	.05"	Y8MRB-1 (2)	-	-	-	-	-	3/4"															
YAZV10-2TC14-45	2															1/4"	3/4"	.41"	.69"	.05"	2.16"									
YAZV10-2TC14-90	3																					1/4"	3/4"	.41"	.69"	.05"	2.03"			
YAZV10-2TC14E2	1			1/4"	3/4"	.41"	.69"	.05"																				1.45"		
YAZV10-2TC14E2-45	2															1/4"	3/4"	.41"	.69"	.05"	2.28"									
YAZV10-2TC14E2-90	3																					1/4"	3/4"	.41"	.69"	.05"	2.16"			
YAZ8C-2TC10	1	#8 STR	†	#10	5/8"	.41"	.75"	.08"	Y1MR (2) Y8MRB-1 (2) Y2MR (2) MY29-3 (2) MY29-11 (2) MRC840 (2)	W8CVT (2) W8CRT (2) X8CRT (2)	W8CVT (2) W8CRT (2) X8CRT (2)	U8CRT (2)	Red	49	7/8"															
YAZ8C-2TC10-45	2															#10	3/4"	.41"	.75"	.08"	2.20"									
YAZ8C-2TC10-90	3																					#10	3/4"	.41"	.75"	.08"	2.09"			
YAZ8C-2TC10E2	1			#10	3/4"	.41"	.75"	.08"																				1.37"		
YAZ8C-2TC10E2-45	2															#10	3/4"	.41"	.75"	.08"	2.33"									
YAZ8C-2TC10E2-90	3																					#10	3/4"	.41"	.75"	.08"	2.22"			
YAZ8C-2TC14	1	#6 SOL	10	1/4"	5/8"	.44"	.75"	.08"	Y1MR (2) Y8MRB-1 (2) Y2MR (2) MY29-3 (2) MY29-11 (2) MRC840 (2)	W8CVT (2) W8CRT (2) X8CRT (2)	W8CVT (2) W8CRT (2) X8CRT (2)	U8CRT (2)	Red	49	7/8"															
YAZ8C-2TC14-45	2															1/4"	5/8"	.44"	.75"	.08"	2.20"									
YAZ8C-2TC14-90	3																					1/4"	5/8"	.44"	.75"	.08"	1.49"			
YAZ8C-2TC14E2	1			1/4"	5/8"	.44"	.75"	.08"																				2.45"		
YAZ8C-2TC14E2-45	2															1/4"	5/8"	.44"	.75"	.08"	2.33"									
YAZ8C-2TC14E2-90	3																					1/4"	5/8"	.44"	.75"	.08"	1.50"			
YAZ8C-2TC14E1	1	#6 SOL	10	1/4"	5/8"	.44"	.75"	.08"	Y1MR (2) Y8MRB-1 (2) Y2MR (2) MY29-3 (2) MY29-11 (2) MRC840 (2)	W8CVT (2) W8CRT (2) X8CRT (2)	W8CVT (2) W8CRT (2) X8CRT (2)	U8CRT (2)	Red	49	7/8"															
YAZ8C-2TC14-45	2															1/4"	5/8"	.44"	.75"	.08"	2.20"									
YAZ8C-2TC14-90	3																					1/4"	5/8"	.44"	.75"	.08"	1.49"			
YAZ8C-2TC14E2	1			1/4"	5/8"	.44"	.75"	.08"																				2.45"		
YAZ8C-2TC14E2-45	2															1/4"	5/8"	.44"	.75"	.08"	2.33"									
YAZ8C-2TC14E2-90	3																					1/4"	5/8"	.44"	.75"	.08"	1.62"			
YAZ8C-2TC14E1	1	#6 SOL	10	1/4"	5/8"	.44"	.75"	.08"	Y1MR (2) Y8MRB-1 (2) Y2MR (2) MY29-3 (2) MY29-11 (2) MRC840 (2)	W8CVT (2) W8CRT (2) X8CRT (2)	W8CVT (2) W8CRT (2) X8CRT (2)	U8CRT (2)	Red	49	7/8"															
YAZ8C-2TC14E1-45	2															1/4"	5/8"	.44"	.75"	.08"	2.70"									
YAZ8C-2TC14E1-90	3																					1/4"	5/8"	.44"	.75"	.08"	2.58"			
YAZ8C-2TC38	1			1/4"	5/8"	.44"	.75"	.08"																				1.87"		
YAZ8C-2TC38-45	2															1/4"	5/8"	.44"	.75"	.08"	2.89"									
YAZ8C-2TC38-90	3																					1/4"	5/8"	.44"	.75"	.08"	2.72"			
YAZ8C-2TC38	1	#6 SOL	10	3/8"	1"	.58"	.75"	.06"	Y1MR (2) Y8MRB-1 (2) Y2MR (2) MY29-3 (2) MY29-11 (2) MRC840 (2)	W8CVT (2) W8CRT (2) X8CRT (2)	W8CVT (2) W8CRT (2) X8CRT (2)	U8CRT (2)	Red	49	7/8"															
YAZ8C-2TC38-45	2															3/8"	1"	.58"	.75"	.06"	2.72"									
YAZ8C-2TC38-90	3																					3/8"	1"	.58"	.75"	.06"	2.05"			
YAZ6C-2N	1			#6 AWG	-	1/2"	1-3/4"	.83"																				1.12"	.12"	Y2MR (2) MY29-3 (2) MY29-11 (2) MRC840 (2) Y644M (1) Y1MR (2)
YAZ6C-2N-45	2															1/2"	1-3/4"	.83"	1.12"	.12"	4.40"									
YAZ6C-2N-90	3																					1/2"	1-3/4"	.83"	1.12"	.12"	4.29"			
YAZ6C-2TC10E2	1	1/2"	1-3/4"			.83"	1.12"	.12"	3.28"																					
YAZ6C-2TC10E2-45	2									1/2"	1-3/4"	.83"	1.12"	.12"	2.65"															
YAZ6C-2TC10E2-90	3															1/2"	1-3/4"	.83"	1.12"	.12"	2.48"									
YAZ6C-2TC10E2	1	#10	3/4"	.42"	1.12"	.09"	2.48"																							
YAZ6C-2TC10E2-45	2							#10	3/4"	.42"	1.12"	.09"	1.51"																	
YAZ6C-2TC10E2-90	3													#10	3/4"	.42"	1.12"	.09"	1.51"											

▲ See tooling section of this catalog for complete tool and die listings.  
 \* Use P-UADP-1 adaptor with "U" -dies in Y46 HYPRESS™.  
 \*\* P-RT die sets for use in Y46 HYPRESS™ only, P-UADP-1 adaptor not required.  
 \*\*\* The MM<sup>2</sup> conductor sizes listed are the recommendations for Class 2 conductor.  
 † The MM<sup>2</sup> conductor size referred to here is for Class 2 and Class 5 conductor.  
 ‡ Available undrilled. Add suffix "U" to catalog number (example: YA25U).  
 ◆ For applications greater than 2000 Volts consult cable manufacturer for voltage stress relief instructions.



## TWO HOLE HYLUG™ CODE CONDUCTOR LONG BARREL WITH INSPECTION WINDOW (CONTINUED)

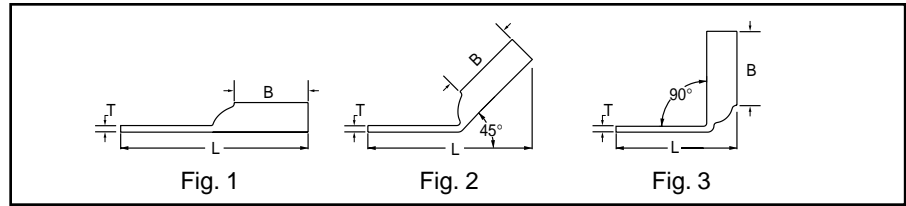

Catalog Number	Fig #	Conductor		Stud Hole Size	Stud Hole Spacing	Tongue Width	Figure Dimensions			Dieless (# of crimps)	▲ Installation Tooling				Wire Strip Length																												
		AWG	MM²				(B)	(T)	(L)		Mechanical		Hydraulic			Color Code	Die Index																										
											MD6, OUR840 MD7-34R	BCT500HS Y500CTHS	Y35, Y39, Y750 Y46, BAT35, BAT750																														
YAZ6C-2TC14	1	#6 AWG	-	1/4"	5/8"	.45"	1.12"	.08"	2.65"	Y1MR (2) Y2MR (2) MY29-3 (2) MY29-11 (2) MRC840 (2) Y644M (2)	W5CVT (2) W5CRT (2) X5CRT (2) X8CART (2)	W5CVT (2) X5CRT (2) X5CRT (2) X8CART (2)	U5CRT (2) U8CABT (2)	Blue	7 or 374	1-1/16"																											
YAZ6C-2TC14-45	2						1.12"	.08"	2.45"																																		
YAZ6C-2TC14-90	3								1.51"																																		
YAZ6C-2TC14E2	1			1/4"	3/4"	.45"	1.12"	.08"	2.78"																																		
YAZ6C-2TC14E2-45	2						1.12"	.08"	2.58"																																		
YAZ6C-2TC14E2-90	3								1.63"																																		
YAZ6C-2TC14E1	1			1/4"	1"	.45"	1.12"	.08"	3.03"																																		
YAZ6C-2TC14E1-45	2						1.12"	.08"	2.83"																																		
YAZ6C-2TC14E1-90	3								1.63"																																		
YAZ6C-2TC38E2	1			3/8"	3/4"	.58"	1.12"	.06"	2.97"																																		
YAZ6C-2TC38E2-45	2						1.12"	.06"	2.72"																																		
YAZ6C-2TC38E2-90	3								1.81"																																		
YAZ6C-2TC38E6	1			3/8"	7/8"	.58"	1.12"	.06"	3.09"																																		
YAZ6C-2TC38E6-45	2						1.12"	.06"	2.85"																																		
YAZ6C-2TC38E6-90	3								1.94"																																		
YAZ6C-2TC38	1	3/8"	1"	.58"	1.12"	.06"	3.22"																																				
YAZ6C-2TC38-45	2				1.12"	.06"	2.97"																																				
YAZ6C-2TC38-90	3						2.06"																																				
YAZ5C-2N	1	#5 AWG	-	1/2"	1-3/4"	.83"	1.12"	.12"	4.43"	W5CRT (2) W5CVT (2) X5CRT (2)	W5CVT (2) W5CRT (2) X5CRT (2)	U5CRT (2)	Blue	7 or 374	1/16"																												
YAZ5C-2N-45	2						1.12"	.12"	4.31"																																		
YAZ5C-2N-90	3								3.28"																																		
YAZ4C-2N	1	#4 AWG	-	1/2"	1-3/4"	.83"	1.12"	.12"	4.42"							W4CVT (2) W4CRT (2) X4CRT (2)	W4CVT (2) W4CRT (2) X4CRT (2)	U4CRT (2) U6CABT (2)	Gray	8 or 346	1-1/16"																						
YAZ4C-2N-45	2						1.12"	.12"	4.30"																																		
YAZ4C-2N-90	3								3.30"																																		
YAZ4C-2TC10-E2	1			#10	3/4"	.49"	1.12"	.09"	2.67"													Y1MR (4) Y2MR (4) MY29-3 (2) MY29-11 (2) MRC840 (2) Y644M (2)	W3CRT (2)	W3CRT (2)	U3CRT (2)	White	9	1-5/16"															
YAZ4C-2TC10-E245	2						1.12"	.09"	2.49"																																		
YAZ4C-2TC10-E290	3								1.54"																																		
YAZ4C-2TC14	1			1/4"	5/8"	.49"	1.12"	.09"	2.67"																				Y1MR (4) Y2MR (4) MY29-3 (2) MY29-11 (2) MRC840 (2) Y644M (2)	W3CRT (2)	W3CRT (2)	U3CRT (2)	White	9	1-5/16"								
YAZ4C-2TC14-45	2						1.12"	.09"	2.49"																																		
YAZ4C-2TC14-90	3								1.54"																																		
YAZ4C-2TC14E2	1			1/4"	3/4"	.49"	1.12"	.09"	2.80"																											Y1MR (4) Y2MR (4) MY29-3 (2) MY29-11 (2) MRC840 (2) Y644M (2)	W3CRT (2)	W3CRT (2)	U3CRT (2)	White	9	1-5/16"	
YAZ4C-2TC14E2-45	2						1.12"	.09"	2.61"																																		
YAZ4C-2TC14E2-90	3								1.66"																																		
YAZ4C-2TC38	1			3/8"	1"	.58"	1.12"	.08"	3.23"	Y1MR (4) Y2MR (4) MY29-3 (2) MY29-11 (2) MRC840 (2) Y644M (2)	W3CRT (2)	W3CRT (2)	U3CRT (2)	White	9																												1-5/16"
YAZ4C-2TC38-45	2						1.12"	.08"	3.01"																																		
YAZ4C-2TC38-90	3								2.09"																																		
YAZ3C-2N	1	#3 AWG	25	1/2"	1-3/4"	.83"	1.25"	.12"	4.58"							W3CRT (2)	W3CRT (2)	U3CRT (2)	White	9	1-5/16"																						
YAZ3C-2N-45	2						1.25"	.12"	4.41"																																		
YAZ3C-2N-90	3								3.32"																																		
YAZ3C-2TC14	1			1/4"	5/8"	.55"	1.25"	.09"	2.83"													W3CRT (2)	W3CRT (2)	U3CRT (2)	White	9	1-5/16"																
YAZ3C-2TC14-45	2						1.25"	.09"	2.59"																																		
YAZ3C-2TC14-90	3								1.55"																																		
YAZ3C-2TC14E2	1			1/4"	3/4"	.55"	1.25"	.09"	2.95"																			W3CRT (2)	W3CRT (2)	U3CRT (2)	White	9	1-5/16"										
YAZ3C-2TC14E2-45	2						1.25"	.09"	2.72"																																		
YAZ3C-2TC14E2-90	3								1.68"																																		
YAZ3C-2TC38E2	1			3/8"	3/4"	.58"	1.25"	.08"	3.14"																									W3CRT (2)	W3CRT (2)	U3CRT (2)	White	9	1-5/16"				
YAZ3C-2TC38E2-45	2						1.25"	.08"	2.88"																																		
YAZ3C-2TC38E2-90	3								1.86"																																		

C-55

▲ See tooling section of this catalog for complete tool and die listings.  
 \* Use P-UADP-1 adaptor with "U" -dies in Y46 HYPRESS™.  
 \*\* P-RT die sets for use in Y46 HYPRESS™ only, P-UADP-1 adaptor not required.

\*\*\* The MM² conductor sizes listed are the recommendations for Class 2 conductor.  
 \* Available undrilled. Add suffix "U" to catalog number (example: YA25U).

◆ For applications greater than 2000 Volts consult cable manufacturer for voltage stress relief instructions.



## TWO HOLE HYLUG™ CODE CONDUCTOR LONG BARREL WITH INSPECTION WINDOW (CONTINUED)

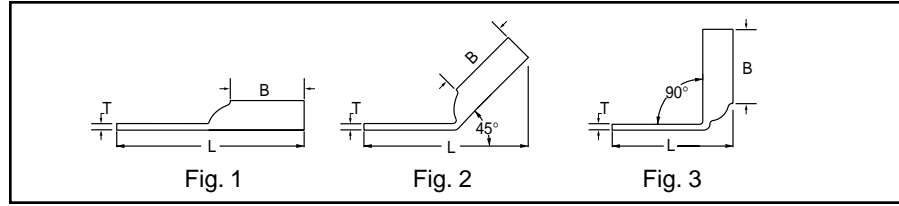

C-56

Catalog Number	Fig #	Conductor		Stud Hole Size	Stud Hole Spacing	Tongue Width	Figure Dimensions			Dieless (# of crimps)	▲ Installation Tooling					Wire Strip Length	
		AWG	*** MM <sup>2</sup>				(B)	(T)	(L)		Mechanical		Hydraulic		Color Code		Die Index
											MD6, OUR840 MD7-34R	BCT500HS Y500CTHS	Y35, Y39, Y750 Y46, BAT35, BAT750				
YAZ3C-2TC38	1	#3 AWG #2 SOL	25	3/8"	1"	.58"	1.25"	.08"	3.39"	Y1MR (4) Y2MR (4) MY29-3 (2) MY29-11 (2) MRC840 (2) Y644M (1)	W3CRT (2)	W3CRT (2)	U3CRT (2)	White	9	1-5/16"	
YAZ3C-2TC38-45	2						1.25"	.08"	3.13"								
YAZ3C-2TC38-90	3						1.25"	.08"	2.11"								
YAZ2C-2N	1	#2 AWG	35	1/2"	1-3/4"	.83"	1.25"	.12"	4.60"	W2CVT (2) W2CRT (2) X2CRT (2)	W2CVT (2) W2CRT (2) X2CRT (2)	U2CRT (2)	Brown	10	1-5/16"		
YAZ2C-2N-45	2						1.25"	.12"	4.32"								
YAZ2C-2N-90	3						1.25"	.12"	3.32"								
YAZ2C-2TC10E2	1			#10	3/4"	.60"	1.25"	.11"	2.85"								
YAZ2C-2TC10E2-45	2						1.25"	.11"	2.65"								
YAZ2C-2TC10E2-90	3						1.25"	.11"	1.58"								
YAZ2C-2TC14	1			1/4"	5/8"	.60"	1.25"	.11"	2.85"								
YAZ2C-2TC14-45	2						1.25"	.11"	2.65"								
YAZ2C-2TC14-90	3						1.25"	.11"	1.58"								
YAZ2C-2TC14E2	1			1/4"	3/4"	.60"	1.25"	.11"	2.97"								
YAZ2C-2TC14E2-45	2						1.25"	.11"	2.77"								
YAZ2C-2TC14E2-90	3						1.25"	.11"	1.71"								
YAZ2C-2TC14E1	1	1/4"	1"	.60"	1.25"	.11"	3.22"										
YAZ2C-2TC14E1-45	2				1.25"	.11"	3.02"										
YAZ2C-2TC14E1-90	3				1.25"	.11"	1.96"										
YAZ2C-2TC516E2	1	#2 AWG	35	5/16"	3/4"	.60"	1.25"	.11"	3.03"	W2CVT (2) W2CRT (2) X2CRT (2)	W2CVT (2) W2CRT (2) X2CRT (2)	U2CRT (2)	Brown	10	1-5/16"		
YAZ2C-2TC516E2-45	2						1.25"	.11"	2.84"								
YAZ2C-2TC516E2-90	3						1.25"	.11"	1.77"								
YAZ2C-2TC38E2	1			3/8"	3/4"	.60"	1.25"	.11"	3.16"								
YAZ2C-2TC38E2-45	2						1.25"	.11"	2.96"								
YAZ2C-2TC38E2-90	3						1.25"	.11"	1.90"								
YAZ2C-2TC38E6	1			3/8"	7/8"	.60"	1.25"	.11"	3.28"								
YAZ2C-2TC38E6-45	2						1.25"	.11"	3.09"								
YAZ2C-2TC38E6-90	3						1.25"	.11"	2.02"								
YAZ2C-2TC38	1			3/8"	1"	.60"	1.25"	.11"	3.41"								
YAZ2C-2TC38-45	2						1.25"	.11"	3.21"								
YAZ2C-2TC38-90	3						1.25"	.11"	2.14"								
YAZ2C-2NTC38	1	3/8"	1-3/4"	.60"	1.25"	.11"	4.16"										
YAZ2C-2NTC38-45	2				1.25"	.11"	3.96"										
YAZ2C-2NTC38-90	3				1.25"	.11"	2.90"										
YAZ1C-2N	1	#1 AWG	50	1/2"	1-3/4"	.83"	1.38"	.12"	4.76"	Y1MR (4) MY29-3 (2) MY29-11 (2) MRC840 (2) Y644M (1)	W1CVT (2) W1CRT-1 (2) X1CRT-1 (2)	W1CVT (2) W1CRT-1 (2) X1CRT-1 (2)	U1CRT-1 (2) U4CABT (2)	Green	11 or 375	1-7/16"	
YAZ1C-2N-45	2						1.38"	.12"	4.45"								
YAZ1C-2N-90	3						1.38"	.12"	3.34"								
YAZ1C-2TC14	1			1/4"	5/8"	.67"	1.38"	.10"	3.01"								
YAZ1C-2TC14-45	2						1.38"	.10"	2.75"								
YAZ1C-2TC14-90	3						1.38"	.10"	1.60"								
YAZ1C-2TC14E2	1			1/4"	3/4"	.67"	1.38"	.10"	3.13"								
YAZ1C-2TC14E2-45	2						1.38"	.10"	2.87"								
YAZ1C-2TC14E2-90	3						1.38"	.10"	1.73"								
YAZ1C-2TC38	1			3/8"	1"	.67"	1.38"	.10"	3.57"								
YAZ1C-2TC38-45	2						1.38"	.10"	3.31"								
YAZ1C-2TC38-90	3						1.38"	.10"	2.16"								
YAZ25-2N	1	1/0 AWG	-	1/2"	1-3/4"	.83"	1.38"	.11"	4.79"	MY29-3 (2) MY29-11 (2) MRC840 (4) Y644M (1)	W25RT (4) W25VT (4) X25RT (4)	W25VT (4) X25RT (4) W25RT (4)	U25RT (2) U2CABT (2)	Pink	12 or 348	1-7/16"	
YAZ25-2N-45	2						1.38"	.11"	4.52"								
YAZ25-2N-90	3						1.38"	.11"	3.38"								

▲ See tooling section of this catalog for complete tool and die listings.

\* Use P-UADP-1 adaptor with "U" -dies in Y46 HYPRESS™.

\*\* P-RT die sets for use in Y46 HYPRESS™ only, P-UADP-1 adaptor not required.

\*\*\* The MM<sup>2</sup> conductor sizes listed are the recommendations for Class 2 conductor.

\* Available undrilled. Add suffix "U" to catalog number (example: YA25U).

◆ For applications greater than 2000 Volts consult cable manufacturer for voltage stress relief instructions.



### TWO HOLE HYLUG™ CODE CONDUCTOR LONG BARREL WITH INSPECTION WINDOW (CONTINUED)

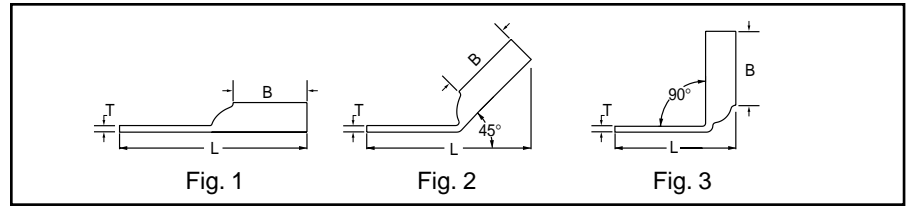

Catalog Number	Fig #	Conductor					▲ Installation Tooling					Wire Strip Length					
		AWG	MM <sup>2</sup>	Stud Hole Size	Stud Hole Spacing	Tongue Width	Figure Dimensions		Dieless (# of crimps)	Mechanical MD6, OUR840 MD7-34R	Hydraulic		Color Code	Die Index			
							(B)	(T)			(L)				BCT500HS Y500CTHS	Y35, Y39, Y750 Y46, BAT35, BAT750	
YAZ25-2TC14	1	1/0 AWG	-	1/4"	5/8"	.75"	1.38"	.12"	MY29-3 (2) MY29-11 (2) MRC840 (4) Y644M (1)	W25RT (4) W25VT (4) X25RT (4)	W25VT (4) W25RT (4) W25RT (4)	U25RT (2) U2CABT (2)	Pink	12 or 348	1-7/16"		
YAZ25-2TC14-45	2															3.04"	
YAZ25-2TC14-90	3															2.81"	
YAZ25-2TC14E2	1															1.64"	
YAZ25-2TC14E2-45	2															3.16"	
YAZ25-2TC14E2-90	3															2.93"	
YAZ25-2TC14E1	1			1.76"													
YAZ25-2TC14E1-45	2			3.41"													
YAZ25-2TC14E1-90	3			3.18"													
YAZ25-2TC516E6	1			2.01"													
YAZ25-2TC516E6-45	2			3.35"													
YAZ25-2TC516E6-90	3			3.12"													
YAZ25-2TC516	1			1.95"													
YAZ25-2TC516-45	2			3.47"													
YAZ25-2TC516-90	3			3.24"													
YAZ25-2TC38	1			2.08"													
YAZ25-2TC38-45	2			3.60"													
YAZ25-2TC38-90	3			3.37"													
YAZ25-2NTC38	1	2.20"															
YAZ25-2NTC38-45	2	4.35"															
YAZ25-2NTC38-90	3	4.12"															
YAZ26-2N	1	2/0 AWG	70	1/2"	1 3/4"	.83"	1.50"	.12"	MY29-3 (2) MY29-11 (2) MRC840 (4) Y644M (1)	W26VT (4) W26RT (4) X26RT (4)	W26VT (4) W26RT (4) X26RT (4)	U26RT (2)	Black	13	1-9/16"		
YAZ26-2N-45	2															4.95"	
YAZ26-2N-90	3															4.67"	
YAZ26-2TC14	1															3.41"	
YAZ26-2TC14-45	2															3.20"	
YAZ26-2TC14-90	3															2.92"	
YAZ26-2TC14E2	1			1.66"													
YAZ26-2TC14E2-45	2			3.32"													
YAZ26-2TC14E2-90	3			3.05"													
YAZ26-2TC38	1			1.79"													
YAZ26-2TC38-45	2			3.76"													
YAZ26-2TC38-90	3			3.48"													
YAZ27-2N	1			2.22"													
YAZ27-2N-45	2			4.98"													
YAZ27-2N-90	3			4.71"													
YAZ27-2TC14E2	1			3.44"													
YAZ27-2TC14E2-45	2			3.36"													
YAZ27-2TC14E2-90	3			3.08"													
YAZ27-2TC38	1	1.82"															
YAZ27-2TC38-45	2	3.80"															
YAZ27-2TC38-90	3	3.52"															
YAZ28-2N	1	3/0 AWG	-	1/2"	1-3/4"	.90"	1.50"	.12"	MY29-3 (2) MY29-11 (2) MRC840 (4) Y644M (1)	W27VT (4) W27RT (4) X27RT (6)	W27VT (4) W27RT (4) X27RT (6)	U27RT (2)	Orange	14	1-9/16"		
YAZ27-2N-45	2															4.98"	
YAZ27-2N-90	3															4.71"	
YAZ27-2TC14E2	1															3.44"	
YAZ27-2TC14E2-45	2															3.36"	
YAZ27-2TC14E2-90	3															3.08"	
YAZ27-2TC38	1	1.82"															
YAZ27-2TC38-45	2	3.80"															
YAZ27-2TC38-90	3	3.52"															
YAZ28-2N	1	4/0 AWG	-	1/2"	1-3/4"	1.02"	1.62"	.14"		MY29-3 (2) MY29-11 (2) MRC840 (4) Y644M (1)	W28VT (4) W28RT (4) X28RT (6)	W28VT (4) W28RT (4) X28RT (6)	U28RT (2)	Purple	15	1-11/16"	
YAZ28-2N-45	2																5.15"
YAZ28-2N-90	3																4.86"
YAZ28-2TC14E2	1																3.48"
YAZ28-2TC14E2-45	2																3.55"
YAZ28-2TC14E2-90	3																3.25"
YAZ28-2TC38	1	1.86"															
YAZ28-2TC38-45	2	3.80"															
YAZ28-2TC38-90	3	3.52"															

C-57

▲ See tooling section of this catalog for complete tool and die listings.  
 \* Use P-UADP-1 adaptor with "U" -dies in Y46 HYPRESS™.  
 \*\* P-RT die sets for use in Y46 HYPRESS™ only, P-UADP-1 adaptor not required.

\*\*\* The MM<sup>2</sup> conductor sizes listed are the recommendations for Class 2 conductor.  
 \* Available undrilled. Add suffix "U" to catalog number (example: YA25U).

◆ For applications greater than 2000 Volts consult cable manufacturer for voltage stress relief instructions.



### TWO HOLE HYLUG™ CODE CONDUCTOR LONG BARREL WITH INSPECTION WINDOW (CONTINUED)

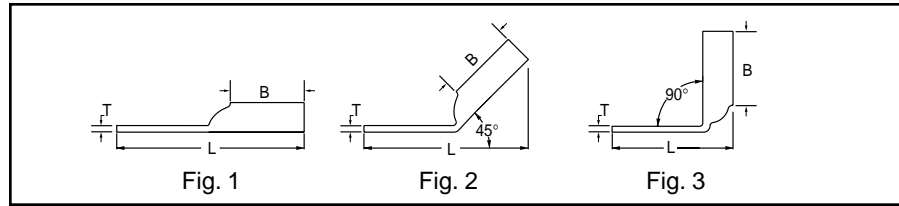

C-58

Catalog Number	Fig #	Conductor					▲ Installation Tooling										Wire Strip Length								
		AWG	MM <sup>2</sup>	Stud Hole Size	Stud Hole Spacing	Tongue Width	Figure Dimensions			Dieless (# of crimps)	Mechanical		Hydraulic		Color Code	Die Index									
							(B)	(T)	(L)		MD6, OUR840 MD7-34R	BCT500HS Y500CTHS	Y35, Y39, Y750 Y46, BAT35, BAT750												
YAZ28-2TC38	1	4/0 AWG	-	3/8"	1"	1.02"	1.62"	.14"	3.99"	MY29-3 (2) MY29-11 (2) MRC840 (4) Y644M (1)	W28VT (4) W28RT (4) X28RT (6)	W28VT (4) W28RT (4) X28RT (6)	U28RT (2)	Purple	15	1-11/16"									
YAZ28-2TC38-45	2						1.62"	.14"	3.69"																
YAZ28-2TC38-90	3						1.62"	.14"	2.30"																
YAZ28-2NTC38	1			3/8"	1-3/4"	1.02"	1.62"	.14"	4.74"																
YAZ28-2NTC38-45	2						1.62"	.14"	4.44"																
YAZ28-2NTC38-90	3	1.62"	.14"				3.05"																		
YAZ29-2N	1	250 kcmil	-	1/2"	1-3/4"	1.10"	1.62"	.16"	5.18"	MY29-3 (2) MY29-11(2) Y644M (1)	W29VT (4) X29RT (8)	X29RT (8) W29VT (4) W29RT (4)	U29RT (2)	Yellow	16	1-11/16"									
YAZ29-2N-45	2						1.62"	.16"	4.92"																
YAZ29-2N-90	3						1.62"	.16"	3.52"																
YAZ29-2TC38	1			3/8"	1"	1.10"	1.62"	.14"	3.99"																
YAZ29-2TC38-45	2						1.62"	.14"	3.73"																
YAZ29-2TC38-90	3	1.62"	.14"				2.34"																		
YAZ30-2N	1	300 kcmil	150	1/2"	1-3/4"	1.20"	2.00"	.16"	5.60"	Y644M (1)	W30VT (4)	W30VT (4) W30RT (4)	U30RT (4) U28ART (4)	White	17 or 298	2-1/16"									
YAZ30-2N-45	2						2.00"	.16"	5.23"																
YAZ30-2N-90	3						2.00"	.16"	3.56"																
YAZ30-2TC38	1			3/8"	1"	1.20"	2.00"	.16"	4.42"																
YAZ30-2TC38-45	2						2.00"	.16"	4.04"																
YAZ30-2TC38-90	3	2.00"	.16"				2.37"																		
YAZ31-2N	1	350 kcmil	185	1/2"	1-3/4"	1.29"	2.00"	.18"	5.64"	Y644M (1)	W31VT (4)	W31VT (4) W31RT (4)	U31RT (4) U29ART (4)	Red	18 or 324	2-1/16"									
YAZ31-2N-45	2						2.00"	.18"	5.29"																
YAZ31-2N-90	3						2.00"	.18"	3.60"																
YAZ31-2TC14E2	1			1/4"	3/4"	1.29"	2.00"	.18"	4.02"																
YAZ31-2TC14E2-45	2						2.00"	.18"	3.66"																
YAZ31-2TC14E2-90	3	2.00"	.18"				1.97"																		
YAZ31-2TC38	1	3/8"	1"	1.29"	2.00"	.18"	4.45"																		
YAZ31-2TC38-45	2				2.00"	.18"	4.10"																		
YAZ31-2TC38-90	3				2.00"	.18"	2.41"																		
YAZ32-2N	1	400 kcmil	-	1/2"	1-3/4"	1.40"	2.12"	.19"	5.81"	Y644M (1)	W32VT (4)	W32VT (4) W32RT (4)	U32RT (4) U30ART (4)	Blue	19 or 470	2/16"									
YAZ32-2N-45	2						2.12"	.19"	5.44"																
YAZ32-2N-90	3						2.12"	.19"	3.64"																
YAZ32-2TC38	1			3/8"	1"	1.40"	2.12"	.19"	4.62"																
YAZ32-2TC38-45	2						2.12"	.19"	4.25"																
YAZ32-2TC38-90	3	2.12"	.19"				2.46"																		
YAZ33-2N	1	450 kcmil	-	1/2"	1-3/4"	1.48"	2.13"	.21"	5.89"	Y644M (1)	W33VT (4)	W33VT (4) W33RT (4)	U33RT (4)	Gray	326 or 538	2-5/16"									
YAZ33-2N-45	2						2.13"	.21"	5.54"																
YAZ33-2N-90	3						2.13"	.21"	3.70"																
YAZ34-2N	1			500 kcmil	240	1/2"	1-3/4"	1.55"	2.25"								.23"	6.04"	Y644M (1)	W34VT (4)	W34VT (4) W34RT (4)	U34RT (4) U31ART (4)	Brown	20 or 299	2-5/16"
YAZ34-2N-45	2								2.25"								.23"	5.69"							
YAZ34-2N-90	3	2.25"	.23"						3.73"																
YAZ34-2TC14E2	1	1/4"	3/4"			1.55"	2.25"	.23"	4.42"																
YAZ34-2TC14E2-45	2						2.25"	.23"	4.06"																
YAZ34-2TC14E2-90	3			2.25"	.23"		2.10"																		
YAZ34-2TC38	1	3/8"	1"	1.55"	2.25"	.23"	4.85"																		
YAZ34-2TC38-45	2				2.25"	.23"	4.50"																		
YAZ34-2TC38-90	3				2.25"	.23"	2.54"																		
YAZ35-2N	1	550 kcmil	-	1/2"	1-3/4"	1.65"	2.63"	.25"	6.45"	-	-	U35RT (4)	Yellow	21	2-11/16"										
YAZ35-2N-45	2						2.63"	.25"	6.03"																
YAZ35-2N-90	3						2.63"	.25"	3.77"																

▲ See tooling section of this catalog for complete tool and die listings.  
 \* Use P-UADP-1 adaptor with "U" -dies in Y46 HYPRESS™.  
 \*\* P-RT die sets for use in Y46 HYPRESS™ only, P-UADP-1 adaptor not required.

\*\*\* The MM<sup>2</sup> conductor sizes listed are the recommendations for Class 2 conductor.  
 \* Available undrilled. Add suffix "U" to catalog number (example: YA25U).

◆ For applications greater than 2000 Volts consult cable manufacturer for voltage stress relief instructions.



## TWO HOLE HYLUG™ CODE CONDUCTOR LONG BARREL WITH INSPECTION WINDOW (CONTINUED)

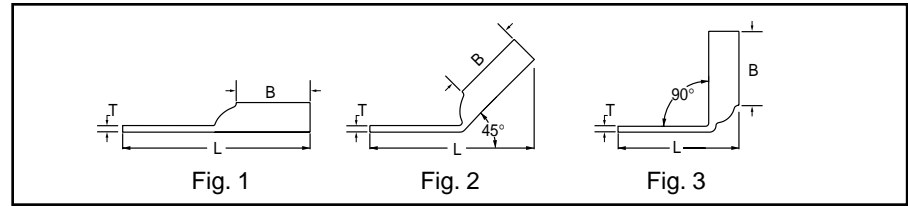

Catalog Number	Fig #	Conductor					▲ Installation Tooling					Wire Strip Length													
		AWG	*** MM <sup>2</sup>	Stud Hole Size	Stud Hole Spacing	Tongue Width	Figure Dimensions			Dieless (# of crimps)	Mechanical MD6, OUR840 MD7-34R		Hydraulic		Color Code	Die Index									
							(B)	(T)	(L)				BCT500HS Y500CHS	Y35, Y39, Y750 Y46, BAT35, BAT750											
YAZ36-2N	1	600 kcmil	300	1/2"	1-3/4"	1.74"	2.69"	.27"	6.55"	Y644M (1)	-	-	U36RT (4) U32ART (4)	Green	22 or 472	2/4"									
YAZ36-2N-45	2						2.69"	.27"	6.14"																
YAZ36-2N-90	3						2.69"	.27"	3.81"																
YAZ36-2TC38	1			3/8"	1"	1.74"	2.69"	.26"	5.55"																
YAZ36-2TC38-45	2						2.69"	.26"	5.14"																
YAZ36-2TC38-90	3						2.69"	.26"	2.81"																
YAZ37-2N	1	650 kcmil	-	1/2"	1-3/4"	1.80"	2.81"	.27"	6.70"	Y644M (1)	-	-	U37RT (4)	Orange	23	2-7/8"									
YAZ37-2N-45	2						2.81"	.27"	6.26"																
YAZ37-2N-90	3						2.81"	.27"	3.84"																
YAZ38-2N	1	700 kcmil	-	1/2"	1-3/4"	1.84"	2.81"	.27"	6.72"								Y644M (1)	-	-	U38RT (4)	Pink	400	2-7/8"		
YAZ38-2N-45	2						2.81"	.27"	6.26"																
YAZ38-2N-90	3						2.81"	.27"	3.84"																
YAZ39-2N	1			750 kcmil	-	1/2"	1-3/4"	1.91"	2.88"	.27"	6.82"	Y644M (1)	-	-	U39RT (4) P39RT (4) **	Black								24	2-15/16"
YAZ39-2N-45	2								2.88"	.27"	6.34"														
YAZ39-2N-90	3								2.88"	.27"	3.87"														
YAZ39-2NT38	1	3/8"	1"			1.63"	2.88"	.27"	5.82"																
YAZ39-2NT38-45	2						2.88"	.27"	5.34"																
YAZ39-2NT38-90	3						2.88"	.27"	2.87"																
YAZ39-2TC38	1	3/8"	1"			1.91"	2.88"	.27"	5.82"																
YAZ39-2TC38-45	2						2.88"	.27"	5.34"																
YAZ39-2TC38-90	3						2.88"	.27"	2.87"																
YAZ39-2NNT	1	1/2"	1-3/4"			1.63"	2.88"	.27"	6.82"																
YAZ39-2NNT-45	2						2.88"	.27"	6.34"																
YAZ39-2NNT-90	3						2.88"	.27"	3.87"																
YAZ40-2N	1	800 kcmil	400	1/2"	1-3/4"	1.98"	2.94"	.30"	6.89"	Y644M (1)	-	-	P40RT (4) **	Orange	25	3"									
YAZ40-2N-45	2						2.94"	.30"	6.46"																
YAZ40-2N-90	3						2.94"	.30"	3.91"																
YAZ41-2N	1	850 kcmil	-	1/2"	1-3/4"	2.01"	2.94"	.31"	6.91"								Y644M (1)	-	-	-	Gold	-	3"		
YAZ41-2N-45	2						2.94"	.31"	6.48"																
YAZ41-2N-90	3						2.94"	.31"	3.93"																
YAZ44-2N	1	1000 kcmil	500	1/2"	1-3/4"	2.19"	3.00"	.33"	7.08"	Y644M (1)	-	-	P44RT (4) **	White	27	3-1/16"									
YAZ44-2N-45	2						3.00"	.33"	6.66"																
YAZ44-2N-90	3						3.00"	.33"	4.02"																
YAZ44-2TC38	1			3/8"	1"	2.19"	3.00"	.33"	6.09"																
YAZ44-2TC38-45	2						3.00"	.33"	5.66"																
YAZ44-2TC38-90	3						3.00"	.33"	3.02"																
YAZ45-2N	1	1250 kcmil	-	1/2"	1-3/4"	2.46"	3.19"	.38"	7.38"	Y644M (1)	-	-	P45RT (6) **	Yellow	29	3-1/4"									
YAZ45-2N-45	2						3.19"	.38"	6.99"																
YAZ45-2N-90	3						3.19"	.38"	4.13"																
YAZ453-2N	1	1300 kcmil	-	1/2"	1-3/4"	2.53"	3.19"	.39"	7.41"								Y644M (1)	-	-	-	Orange	30	2-1/16"		
YAZ453-2N-45	2						3.19"	.39"	7.03"																
YAZ453-2N-90	3						3.19"	.39"	4.16"																
YAZ46-2N	1	1500 kcmil	-	1/2"	1-3/4"	2.69"	3.19"	.40"	7.48"	Y644M (1)	-	-	P46RT (6) **	Green	31	3-5/16"									
YAZ46-2N-45	2						3.19"	.40"	7.10"																
YAZ46-2N-90	3						3.19"	.40"	4.22"																
YAZ47-2N	1	1750 kcmil	-	1/2"	1-3/4"	2.90"	3.44"	.42"	7.82"								Y644M (1)	-	-	-	Gray	33	3-1/2"		
YAZ47-2N-45	2						3.44"	.42"	7.40"																
YAZ47-2N-90	3						3.44"	.42"	4.30"																

▲ See tooling section of this catalog for complete tool and die listings.  
 \* Use P-UADP-1 adaptor with "U" -dies in Y46 HYPRESS™.  
 \*\* P-RT die sets for use in Y46 HYPRESS™ only, P-UADP-1 adaptor not required.

\*\*\* The MM<sup>2</sup> conductor sizes listed are the recommendations for Class 2 conductor.  
 \* Available undrilled. Add suffix "U" to catalog number (example: YA25U).

◆ For applications greater than 2000 Volts consult cable manufacturer for voltage stress relief instructions.



### TWO HOLE HYLUG™ CODE CONDUCTOR LONG BARREL WITH INSPECTION WINDOW (CONTINUED)

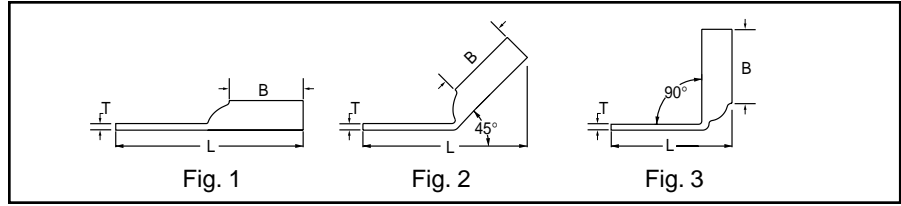

C-60

Catalog Number	Fig #	Conductor		Stud Hole Size	Stud Hole Spacing	Tongue Width	Figure Dimensions			▲ Installation Tooling					Wire Strip Length
		AWG	MM <sup>2</sup>				Dieless (# of crimps)	Mechanical		Hydraulic		Color Code	Die Index		
								MD6, OUR840 MD7-34R	BCT500HS Y500CTHS	Y35, Y39, Y750 Y46, BAT35, BAT750					
YAZ48-2N	1	2000 kcmil	-	1/2"	1-3/4"	3.10"	3.44"	.46"	7.89"	-	-	-	Brown	34	3-1/2"
YAZ48-2N-45	2								7.54"						
YAZ48-2N-90	3								4.40"						

- ▲ See tooling section of this catalog for complete tool and die listings.
- \* Use P-UADP-1 adaptor with "U" dies in Y46 HYPRESS™.
- \*\* P-RT die sets for use in Y46 HYPRESS™ only, P-UADP-1 adaptor not required.
- \*\*\* The MM<sup>2</sup> conductor sizes listed are the recommendations for Class 2 conductor.
- " Available undrilled. Add suffix "U" to catalog number (example: YA25U).
- ◆ For applications greater than 2000 Volts consult cable manufacturer for voltage stress relief instructions.