

Circuit Breakers

Arc-Fault Circuit Interrupters (AFCI)

• Revised •
06/13/14

MURRAY

Combination Type AFCI[®]

AFCI's detect arcing faults (an unintentional arcing condition in a circuit) that standard circuit breakers are unable to detect. The Combination Type AFCI detects all three possible types of arc fault: line-to-ground, line-to-neutral, and series. The device is intended to mitigate the effects of arcing faults by functioning to de-energize the circuit when an arc-fault is detected.

Breaker Type	Ampere Rating	10,000 A IR Catalog Number	22,000 A IR Catalog Number	65,000 A IR Catalog Number
MP-AT2/MP-HAT2/MP-MAT2 1-Pole 120V AC	15 20	MPA115AFC ^① MPA120AFC ^①	MPA115AFCH ^{■①} MPA120AFCH ^{■①}	MPA115AFCHH MPA120AFCHH
MP-AT2/MP-HAT2 2-Pole 120/240V AC	15 20	MP215AFC ^① MP220AFC ^①	MP215AFCH ^{■①} MP220AFCH ^{■①}	— —

Branch-Feeder AFCI

AFCI's detect arcing faults (an unintentional arcing condition in a circuit) that standard circuit breakers are unable to detect. The Branch-Feeder AFCI detects line-to-ground and line-to-neutral arcs. The device is intended to mitigate the effects of arcing faults by functioning to de-energize the circuit when an arc-fault is detected.

Breaker Type	Ampere Rating	10,000 A IR Catalog Number	22,000 A IR Catalog Number	65,000 A IR Catalog Number
MP-AT2/MP-HAT2/MP-MAT2 1-Pole 120V AC	15 20	MPA115AF ^① MPA120AF ^①	MPA115AFH ^{■①} MPA120AFH ^{■①}	MPA115AFHH MPA120AFHH

NEW Dual Function AFCI/GFCI

The Dual Function Circuit Breaker combines Combination Type AFCI and GFCI, protecting against both Arc Faults and Ground Faults. The device includes the Self Test and Lockout feature, making it the first in class in electrical safety for homeowners.

Breaker Type	Ampere Rating	10,000 A IR Catalog Number	22,000 A IR Catalog Number	65,000 A IR Catalog Number
MP-GAT2/MP-HGAT2/MP-MGAT2 1-Pole 120V AC	15 20	MP115DF MP120DF	MP115DFH MP120DFH	MP115DFM MP120DFM

Ground-Fault Circuit Interrupters (Class A - 5mA)[®]

Ground-fault circuit interrupters (GFCI) provide Class A ground fault protection. A GFCI is a device intended for personnel protection and will de-energize the circuit when a fault current to ground is 6 milliamperes or more.

Breaker Type	Amp Rating	10,000 A IR Catalog No.	22,000 A IR Catalog No.
MP-GT/MP-HGT 1-Pole 120V AC	15	MP115GF ^①	MP115GFH ^{■①}
	20	MP120GF ^①	MP120GFH ^{■①}
	25	MP125GF [■]	—
	30	MP130GF	MP130GFH [■]
MP-GT/MP-HGT 2-Pole 120/240V AC	15	MP215GF	MP215GFH [■]
	20	MP220GF	MP220GFH [■]
	30	MP230GF	MP230GFH [■]
	40	MP240GF	MP240GFH [■]
	50	MP250GF	MP250GFH [■]
	60	MP260GF	MP260GFH [■]

Ground Fault Equipment Protection (30mA)[®]

Type EQF circuit breakers provide protection of equipment from damaging line-to-ground fault currents by de-energizing the circuit for all ungrounded conductors of the faulted circuit.

Breaker Type	Amp Rating	10,000 A IR Catalog No.	22,000 A IR Catalog No.
MP-ET/MP-HET 1-Pole 120V AC	15	MP115EG ^①	MP115EGH ^{■①}
	20	MP120EG ^①	MP120EGH ^{■①}
	30	MP130EG	MP130EGH [■]
MP-ET/MP-HET 2-Pole 120/240V AC	15	MP215EG	MP215EGH [■]
	20	MP220EG	MP220EGH [■]
	30	MP230EG	MP230EGH [■]
	40	MP240EG	MP240EGH [■]
	50	MP250EG	MP250EGH [■]
	60	MP260EG [■]	MP260EGH [■]

AFCI and GFCI Accessories

Description	Catalog Number
Padlocking Device for 1" & Twin Breakers	ECPLD1
Padlocking Device for 2" & Quad Breakers	ECPLD2
Handle Blocking Device for 1/2" Circuit Breakers	ECBX231M

■ Built to order. Allow 2-3 weeks for delivery.
①UL Listed as SWD (Switching Duty) Rated, suitable for 120V AC Fluorescent Lighting.

②White line neutral (pigtail) must be connected to the panel neutral for the device to function.

- UL Listed
- HACR & SWD Rated
- Standard 1 inch per pole format with plug-in design

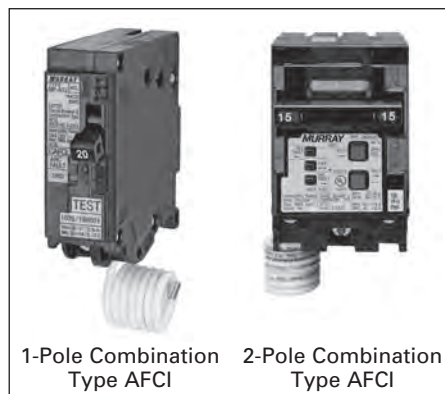

1-Pole Combination Type AFCI 2-Pole Combination Type AFCI



1-Pole Branch Feeder AFCI

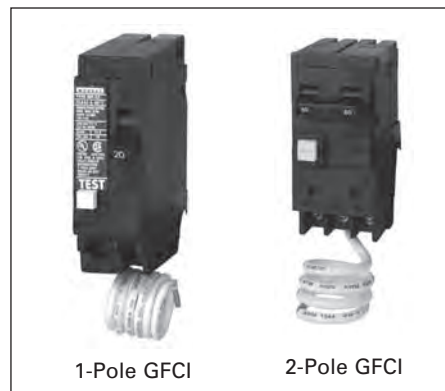

1-Pole GFCI 2-Pole GFCI

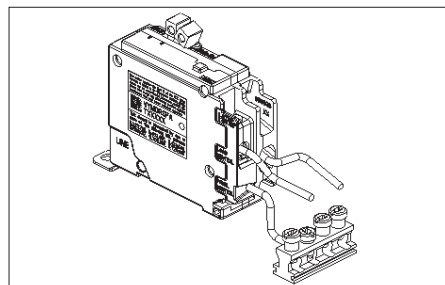

3
MURRAY

Circuit Breakers

Circuit Breakers

Full Size (1" per Pole) with INSTA-WIRE

Continuous Current Rating @ 40° C	Type MP-T ^①	Type MP-HT	Type MP-MT
	10,000A IR	22,000A IR	65,000A IR
	Catalog Number	Catalog Number	Catalog Number

1-Pole Plug-In (120V AC)^⑤

Rating	MP-T	MP-HT	MP-MT
10	MP110	—	—
15	MP115 ^④	MP115KH ^④	MP115KM ^④
20	MP120 ^④	MP120KH ^④	MP120KM ^④
25	MP125	MP125KH■	MP125KM■
30	MP130	MP130KH	MP130KM■
35	MP135■	MP135KH■	MP135KM■
40	MP140	MP140KH	MP140KM■
45	MP145■	MP145KH■	MP145KM■
50	MP150	MP150KH	MP150KM■
60	MP160■	MP160KH■	MP160KM■
70	MP170■	MP170KH■	MP170KM■

2-Pole Plug-In (Common-Trip 120/240V AC)^④

Rating	MP-T	MP-HT	MP-MT
15	MP215	MP215KH	MP215KM■
20	MP220	MP220KH	MP220KM■
25	MP225	MP225KH■	MP225KM■
30	MP230	MP230KH	MP230KM■
35	MP235	MP235KH■	MP235KM■
40	MP240	MP240KH	MP240KM■
45	MP245	MP245KH■	MP245KM■
50	MP250	MP250KH	MP250KM■
60	MP260	MP260KH	MP260KM■
70	MP270	MP270KH■	MP270KM■
80	MP280	MP280KH■	—
90	MP290	MP290KH■	MP290KM■
100	MP2100	MP2100KH	MP2100KM
110	MP2110	MP2110KH	MP2110KM■
125	MP2125	MP2125KH	MP2125KM

2-Pole Plug-In (Common-Trip 240V AC)^{③④}

Rating	MP-T	MP-HT	MP-MT
15	MPH215	—	—
20	MPH220	—	—
30	MPH230	—	—
40	MPH240■	—	—
50	MPH250	—	—
60	MPH260	—	—
70	MPH270■	—	—
100	MPH2100■	—	—

3-Pole Plug-In (Common-Trip 240V AC)^⑦

Rating	MP-T	MP-HT	MP-MT
15	MP315	MP315KH	MP315KM■
20	MP320	MP320KH	MP320KM■
25	MP325■	MP325KH■	—
30	MP330	MP330KH	MP330KM
35	MP335■	—	—
40	MP340	MP340KH	MP340KM
45	MP345■	—	—
50	MP350	MP350KH	MP350KM
60	MP360	MP360KH	MP360KM
70	MP370	MP370KH	MP370KM■
80	MP380	MP380KH■	MP380KM■
90	MP390	MP390KH■	MP390KM■
100	MP3100	MP3100KH	MP3100KM

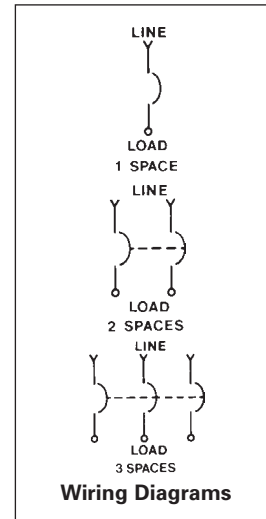
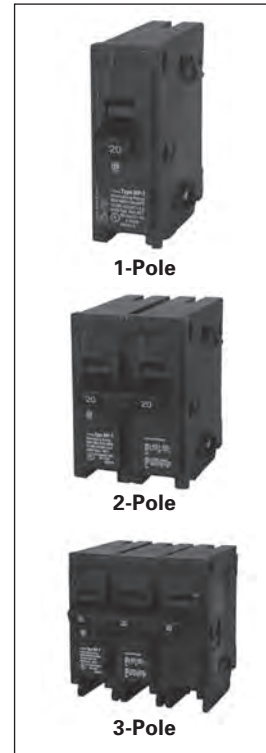

MP-T / MP-HT / MP-MT Internal Accessories

Description	Catalog Number	Field/Factory Installed
120V Shunt Trip	add suffix...ST■	Factory
24V Shunt Trip	add suffix...ST24V■	Factory
120V Auxiliary Switch	add suffix...AS■ ^②	Factory

Modifications

Description	Catalog Number
400Hz Calibration	add suffix...Y ^⑥
Marine 50° C Ambient Calibration	add suffix...M
Fungus Proofing	add suffix...F

For external accessories please refer to page 3-20.

■ Built to order. Allow 2-3 weeks for delivery

① UL Listed for use with 60/75° wire through 40 amps, UL listed for use with 75° wire only for 50 amps and above, HACR rated. 120V AC Fluorescent Lighting.

② 1A and 1B contacts.

③ UL Listed for use on 3 phase grounded "B" systems — 10,000 for this application.

④ UL Listed for frequent switching applications (SWD).

⑤ Shipped 12 per sleeve.

⑥ Shipped 6 per sleeve.

⑦ Shipped 4 per sleeve.

⑧ UL Listed 5KA IR.

⑨ Not UL Listed.

⑩ 1 & 2 Poles only.

Circuit Breakers

Duplex, Triplex and Quadplex Plug-in Breakers

Duplex Circuit Breakers

Breaker Type	Ampere Rating	Catalog Number	Catalog Number
MH-T 1-Pole 10K AIC 120V AC	15-15	MP1515	MP1515N①
	15-20	MP1520	MP1520N■①
	20-20	MP2020	MP2020N①
	20-30	MP2030	MP2030N■①
	15-30	MP3015■	MP3015N■①
	30-30	MP3030	MP3030N■①
SHIPPING: 12 per carton, (Wt. 4.8 lbs.)			

MH-T Duplex

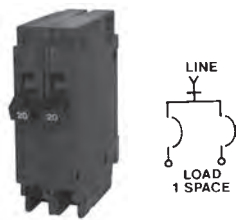

These space saver duplex breakers combine two independent 1/2" breaker poles in a common unit. This unit plugs into one load center stab and requires one panel space. HACR rated.

Triplex Circuit Breakers

Breaker Type	Ampere Rating		Catalog Number
	Single Pole	Common-Trip 2-Pole	
MH-T 2-Pole 10K AIC 120/240V AC Inner Poles Common Trip. Outer Poles 1 Pole Units	15	15	MP21515
	15	20	MP22015
	15	25	MP22515■
	15	30	MP23015
	15	35	MP23515■
	15	40	MP24015
	15	45	MP24515■
	15	50	MP25015
	20	20	MP22020
	20	25	MP22520■
	20	30	MP23020
	20	35	MP23520■
	20	40	MP24020
	20	45	MP24520■
	20	50	MP25020
	SHIPPING: 6 per carton, (Wt. 4.9 lbs.)		

MH-T Triplex

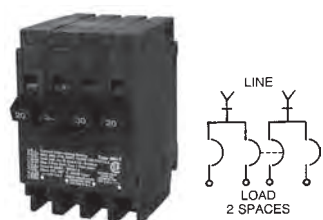

These space saver triplex breakers provide a 2-pole common trip breaker for 120/240V AC circuits and two single poles for 120V AC circuits. Triplex require two panel spaces. HACR rated.

Quadplex Circuit Breakers

Breaker Type	Ampere Rating		Catalog Number
	Single Pole	Common-Trip 2-Pole	
MH-T 2-Pole 10K AIC 120/240V AC Outer and Inner 2 Poles Common Trip	15	15	MP215215CT2
	15	20	MP220220CT2
	20	30	MP220230CT2
	20	40	MP220240CT2
	30	30	MP230230CT2
	30	40	MP230240CT2
	40	40	MP240240CT2
	50	30	MP250230CT2
SHIPPING: 6 per carton, (Wt. 4.8 lbs.)			

MH-T Quadplex

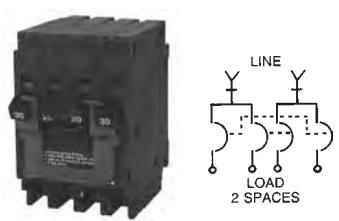

These space saver quadplex breakers provide two sets of common trip, two-pole breakers for 120/240V AC circuits, and require two panel spaces. HACR rated.

For external accessories please refer to page 3-20.

■ Built to order. Allow 2-3 weeks for delivery.

①Non-CTL. For replacement use only in panels manufactured before 1968.

Circuit Breaker and Surge Protective Device (SPD)

Features

- 2 inch wide plug-on design
 - Includes (2) 1 Pole circuits breakers
 - No loss of load center spaces
- Easy to install and perfect for retrofit
- LEDs provide protection status

Benefits

By installing a Siemens Circuit Breaker and Surge Protective Device (SPD) in the load center of the residence, surge protection is provided for all branch circuits^①.

Two green LED indicator lights are provided to show that surge protection is provided for all circuits connected to the load center. These breakers should be used for circuit protection of frequently used household or facility circuits because the lights and devices connected to these circuits provide an effective indication that surge protection is being provided.

The circuit breaker and SPD utilize Siemens-built 150V AC, 40mm, metal oxide varistors (MOVs). The maximum impulse rating for the SPD module is 40kA. The standard interrupting rating for the circuit breakers is 10k AIC. All Type QP circuit breakers and SPD are plug-on style, with load terminals provided. The devices are rated for 120/240V AC and are calibrated for 40 degrees C maximum ambient applications.



Breaker Type	Ampere Rating	Catalog Number	Surge Type
QP 1- Pole 120/240V AC 10K AIC	(2) 15	MSA1515SPD	SPD
	(2) 20	MSA2020SPD	SPD

Catalog Number	MSA1515SPD MSA2020SPD
Amperage	15 or 20 Amp
Number of Poles	(2) 1-Pole Circuit Breakers
Initial Clamping Level	240 Volts
Transient Energy Rating	360 Joules line-to-neutral 720 Joules line-to-line
Transient Suppression	500 volts peak, line-to-neutral
Voltage Rating	1000 volts peak, line-to-line
Peak Current Rating (impulse)	40,000 amperes
Discharge Voltage Characteristic	@ 1,500A, 600 volts @ 5,000A, 800 volts (both line-to-neutral)
Discharge Current Withstand Rating	10,000 amperes line-to-neutral
Circuit Breaker Interrupting Rating	10,000A, 120/240V AC
Listings/Certifications	UL, CSA Meets UL 1449 3rd Edition

^① For warranty information please refer to the surge website www.usa.siemens.com/surge

Special Application Breakers

HID Lighting

For high-intensity discharge lamp loads having in-rush currents above the instantaneous trip setting of a standard breaker..

Breaker Type	Wiring Diagram	Complete Breaker UL Unenclosed	
		Ampere Rating	Catalog Number
MP-T 1-Pole 120V AC	Figure 1	15	MP115HID■①
		20	MP120HID■①
		30	MP130HID■
QP 2-Pole 120/240V AC	Figure 1	15	MP215HID■
		20	MP220HID■
		30	MP230HID■

Molded Case Switch

Molded case non-automatic switch does not provide overload protection.

MP-T 2-Pole 240V AC Plug-In	Figure 2	30	MP260NA
		60	MP230NA

Switched Neutrals

For use where all conductors are required to be disconnected. Neutral pole of breaker does not connect to loadcenter bus. One side is wired to neutral and the other to the device.

MG 2-Wire Common Trip 120V AC	Figure 3	15	MP215SN
		20	MP220SN
		30	MP230SN■
MG 3-Wire Common Trip 120/240V AC	Figure 4	15	MP315SN■
		20	MP320SN
		30	MP330SN■

Tungsten Lighting

For high wattage, tungsten-lamp loads having in-rush currents above the instantaneous trip setting of a standard breaker.

MP-T 1-Pole 120V AC	Figure 1	15	MP115T■
		20	MP120T■

Water Heater

Circuit breaker does not make electrical connection with loadcenter bus. Separate metered circuit is connected to the line terminals of the breaker. Used in special rate water heating areas.

MW 2-Pole 120/40V AC Plug-In	Figure 4	15	MP215WH■
		20	MP220WH
		30	MP230WH



Switched Neutrals



Water Heater

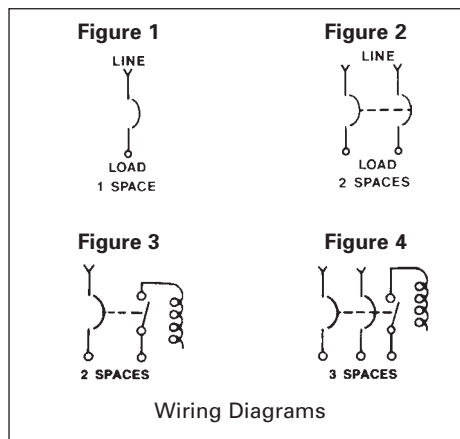

Wiring Diagrams

■ Built to order. Allow 2-3 weeks for delivery.
 Note: All circuit breakers on this page are 10K AIC

① UL Listed as SWD (Switching Duty) Rated, suitable for 120V AC Fluorescent Lighting.

Type MSQ, 3/4 Inch Plug-In Breakers

Features

- 3/4" format.
- HACR Rated.
- UL Classified for use in certain Square D® load centers.

Type MSQ Circuit Breakers

The Type MSQ circuit breaker line is available in 1-pole and 2-pole common trip versions listed on this page.

The circuit breakers are UL Classified and UL Listed.

All MSQ breakers are supplied with load side connectors suitable for 60/75°C wire and are calibrated for 40°C maximum ambient applications.

UL Classified

Murray Type MSQ circuit breakers are UL Classified for use in specific Square D® load centers in place of Square D® Type QO® circuit breakers. A Panelboard Compatibility List packaged with each QD breaker shows which type MSQ circuit breakers are acceptable for use in Square D® load centers.

The interrupting rating on these circuit breakers is 10,000A IR maximum and they are **not** series rated with Square D® circuit breakers or equipment. This UL Classification allows a Murray Type MSQ circuit breaker to be used in place of a Square D® Type QO circuit breaker in those load centers that are specifically shown on the Panelboard Compatibility list. For additional information, contact your local Murray sales engineer.



Continuous Current Rating @ 40°C	1-Pole	2-Pole
	120V	120/240V Common Trip
	Catalog Number	Catalog Number
15	MQ115 ^①	MQ215
20	MQ120 ^①	MQ220
30	MQ130	MQ230
40	MQ140	MQ240
50	MQ150	MQ250
60	MQ160	MQ260

Shipping Weights

Number of Poles	Number Per Carton	Shipping Weight (lbs.)
1	16	3.8
2	8	4.2

Panelboard Compatibility List

Listed Panelboards—Square D®—Catalog Numbers

QO2L30F/S	QO12M100/RB	QO120-30M150/RB	QO130-40M200
QO2-4L70F/S	QO16-20M100/RB	QO124L150G	QO130200/RB
QO2-4L70TS	QO16M100/RB	QO124M150	QO130-40L200G/RB
QO2-4L70RB	QO20M100/RB	QO130L150G/RB	QO140M200/RB
QO6-12L100F/S	QO112L125G/RB	QO130M150/RB	QO16L200/RB
QO6-12L100DF/S	QO112-24L125/RB	QO16L150/RB	QO16M200/RB
QO6-12L100TF/S	QO112-24L125GWGC	QO16M150/RB	QO18-16M200FTRB
QO6-12L100DTF/S	QO116L125G	QO16-30L150/RB	QO20-40L200/RB
QO6-12L100RB	QO116-24L125G/RB	QO18-16M150FTRB	QO20-40M200TF/S
QO8-16L100F/S	QO12-24L125/RB	QO20-30M150/RB	QO20-40M200/RB
QO8-16L100DF/S	QO120-24L125G	QO20-30M150TF/S	QO24L200/RB
QO8-16L100TF/S	QO120-24L125GWGC	QO20-30L150	QO24M200/RB
QO-16L100DTF/S	QO120L125G	QO24L150/RB	QO30L200/RB
QO8-16L100RB	QO124L125G/RB	QO24M150/RB	QO30M200/RB
QO112M100/RB	QO124M125/RB	QO30L150/RB	QO30-40L200/RB
QO116M100/RB	QO16L125/RB	QO30M150/RB	QO30-40M200/RB
QO120M100/RB	QO16-12M125FTRB	QO8-16M200FT/RB	QO40M200/RB
QO124M100	QO16-24L125/RB	QO112L200G/RB	QO140M225
QO12L100DF/S	QO20L125/RB	QO120-40M200/RB	QO142L225G/RB
QO12L100RB	QO20-24L125/RB	QO120-40M200TC	
QO12-20M100/RB	QO24L125/RB	QO124M200	
QO12-20M100TF/S	QO120-30L150G	QO130L200G/RB	

1-Pole 2-Pole Wiring Diagrams

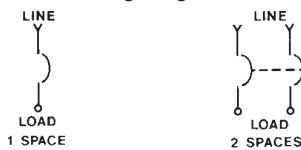

^①UL Listed for frequent switching applications (SWD). 120V AC Fluorescent Lighting. One or two load conductors.
[®]Square D is a registered trademark of Schneider Electric.

Circuit Breakers

MURRAY

Main and Branch Circuit Breakers^①

Breaker Type	Ampere Rating	Catalog Number	Catalog Number ^{②④}	UL Interrupting Ratings (kA)
MD-T^③ 2-Pole 120/240V AC	150	MPD2150	MPD2150R	10
	175	MPD2175■	MPD2175R■	10
	200	MPD2200	MPD2200R	10
MD-HT^③ 2-Pole 120/240V AC	150	MPD2150KH	MPD2150RH	22
	175	MPD2175KH■	MPD2175RH■	22
	200	MPD2200KH	MPD2200RH	22
MD-MT^③ 2-Pole 120/240V AC	150	MPD2150KM	MPD2150RM	65
	175	MPD2175KM■	MPD2175RM■	65
	200	MPD2200KM	MPD2200RM	65



Breaker Type	Ampere Rating	Catalog Number	UL Interrupting Ratings (kA)
M1^⑤ 2-Pole 120/240V AC	100	MBK100M ^⑥	22
	125	MBK125M ^⑥	22
M2^⑤ 2-Pole 120/240V AC	150	MBK150M ^⑥	22
	175	MBK175M ^⑥	22
	200	MBK200M ^⑥	22
	225	MBK225M ^⑥	22



Breaker Type	Ampere Rating	Catalog Number	UL Interrupting Ratings (kA)
ED-A^⑥ 3-Pole 240V AC	125	EP3125	10
	150	EP3150	10
	200	EP3200	10
	175	EP3175	10
	225	EP3225	10

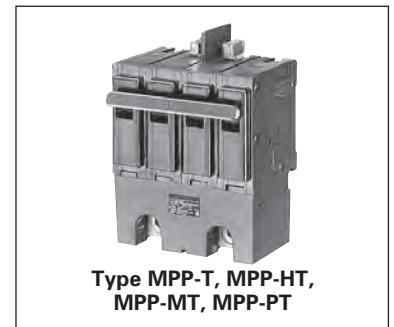

Breaker Type	Ampere Rating	Catalog Number	UL Interrupting Ratings (kA)
MPP^⑦ 2-Pole 120/240V AC	125	MPP2125	10
	150	MPP2150	10
	175	MPP2175■	10
	200	MPP2200	10
	225	MPP2225	10
MPP-HT^⑦ 2-Pole 120/240V AC	125	MPP2125KH	22
	150	MPP2150KH	22
	175	MPP2175KH■	22
	200	MPP2200KH	22
MPP-MT^⑦ 2-Pole 120/240V AC	125	MPP2125KM■	65
	150	MPP2150KM■	65
	175	MPP2175KM■	65
MPP-PT^⑦ 2-Pole 120/240V AC	200	MPP2200KM	65
	225	MPP2225KM■	65
	100	MPP2100KP■	100
	125	MPP2125KP■	100
	150	MPP2150KP■	100
	175	MPP2175KP■	100
	200	MPP2200KP■	100
	225	MPP2225KP■	100

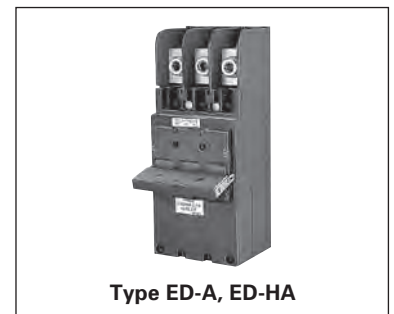

■ Built to order. Allow 2-3 weeks for delivery.

① All circuit breakers on this page are common trip.

② Reverse handle, ON toward lugs. See page 2-23.

③ Requires 4 panel spaces, 2 adjacent, and 2 opposite.

④ For use as load center branch and/or replacement main for old-style load center.

⑤ Main breaker kit for Rock Solid load center

⑥ Requires 6 spaces due to cross over design.

⑦ 4-poles wide for use with 200A modular and Uni-Pak metering

⑧ For use with breaker types MD-T(R), MD-HT(R), MD-MT(R)

⑨ MD-TR required for horizontal mounting applications as shown, or for vertical applications when the lugs are on top. MD-T required for vertical mounting applications with the lugs on the bottom as shown.

⑩ MBK100M for use with 100A and 125A Rock Solid load centers only. MBK125M for use with 125A Rock Solid load centers only.

⑪ MBK150M for use with 150A, 200A, and 225A Rock Solid load centers only. MBK200M for use with 200A and 225A Rock Solid load centers only. MBK225M for use with 225A Rock Solid load centers only.

Circuit Breakers

Circuit Breaker Accessories

• Revised •
06/13/14

MURRAY

Circuit Breaker Accessories ^{④⑤⑥⑦}

Catalog Number	For Use With Breaker Type	Number of Poles	Standard Package
Padlocking Device For locking breaker in "OFF" position. Note "ON" position does not affect breaker functionally			
ECPLD1	Type MP-T, MP-AT2, MP-GT, MP-ET, MH-T-Duplex	1P	3 Pieces
ECPLD2	Type MP-T, MP-AT2, MP-GT, MP-ET, MH-T-Triplex & Quadplex	2P	3 Pieces
ECPLD2R	Type MP-T, MP-AT2, MP-GT, MP-ET, MH-T-Triplex & Quadplex, (Red Color)	2P	3 Pieces
ECPLD3	Type MP-T, MP-AT2, MP-GT, MP-ET	3P	1 Piece
ECPLD3R	Type MP-T, MP-AT2, MP-GT, MP-ET (Red Color)	3P	1 Piece
ECQLD3	Type MP-T	1P	10 Pieces
ECQLD4	Type MH-T-Duplex	QT-Duplex Breakers	10 Pieces
ECQLN3 ^②	150-225 M2, MD-T	n/a	1 Piece
ECQTH4	Type MP-T, BL, BQH	Designed for (3) 1P Breakers	1 Piece
Handle Tie Provide simultaneous switching of 2 adjacent handles.			
ECQTH2	Type MH-T Duplex	Designed for (2) QT Duplex Breakers	25 Pieces
ECQTH3	Type MP-T, BL	2P	50 Pieces
Mechanical Interlock^①			
ECQML12	Type MP-T, Interlock Bracket	Designed for 1" Breaker	10 Pieces
Handle Blocking Device For holding breaker in "ON" or "OFF" position. Not a lockout/tagout device			
ECQL1	Type MP-T	1P	10 Pieces
ECBX231M	Type MH-T-Duplex	1/2" Breakers	10 Pieces
Main Breaker Retainer			
ECMBR2	Rock Solid Load Centers		1 Piece
Mounting Accessories			
I0204ML1125	Type MP-T, Back Mounting Plates	1P, 2P	10 Pieces
I0303ML3100	Type MP-T, Back Mounting Plates	3P	10 Pieces
Filler Plate			
ECQF3	1" Filler Plate	n/a	5 Pieces

■ Built to order. Allow 2-3 weeks for delivery

① For a complete list of standby power mechanical interlock kits, see the Standby Generator Section XXXX

② For use with Murray Rock Solid Center Main Breakers

③ Not suitable for use on 15-50A, 10 AIC Type MP-T Circuit Breakers

④ MP-T Type includes MP-HT, MP-MT

⑤ MP-AT2 Type includes MP-HAT2

⑥ MP-GT Type includes MP-HGT

⑦ MP-ET Type includes MP-HET

Circuit Breaker Accessories

Padlocking Device

**ECPLD1****ECPLD2****ECQLD3****ECQLD4****ECQTH4**

Handle Tie

**ECQTH2****ECQTH3**

Handle Blocking Device

**ECQL1****ECBX231M**

Main Breaker Retainer

**ECMBR2**

Mechanical Interlock

**ECQML12**

Circuit Breakers

MURRAY

Molded Case 60-225 AMP



Wire range is lug capacity. Permissible maximum wire size in an enclosure may be limited by wire bending space.

Required wire sizes by ampere rating are given in National Electric Code or other local codes.

Accessories—See page 3-20.
Line Diagrams—See page 3-23.

Figure 1

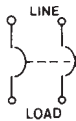
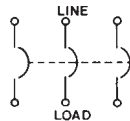

Figure 2



Amps	2 Pole Common Trip 240V AC (Fig. 1)		3 Pole Common Trip 240V AC (Fig. 2)		Wire Range	
	Catalog #	Std. Pkg.- 1 Approx. Wgt. Lbs.	Catalog #	Std. Pkg. - 1 Approx. Wgt. Lbs.	Cu	Al

Type MQ 10,000 AIC

060	MQJ260 ■	3.00	MQJ360 ■	4.10	#6-300 kcmil	#4-300 kcmil
070	MQJ270 ■	3.00	MQJ370 ■	4.10	#6-300 kcmil	#4-300 kcmil
080	MQJ280 ■	3.00	MQJ380 ■	4.10	#6-300 kcmil	#4-300 kcmil
090	MQJ290 ■	3.00	MQJ390 ■	4.10	#6-300 kcmil	#4-300 kcmil
100	MQJ2100 ■	3.00	MQJ3100 ■	4.10	#6-300 kcmil	#4-300 kcmil
110	MQJ2110 ■	3.00	MQJ3110 ■	4.10	#6-300 kcmil	#4-300 kcmil
125	MQJ2125 ■	3.00	MQJ3125 ■	4.10	#6-300 kcmil	#4-300 kcmil
150	MQJ2150 ■	3.00	MQJ3150 ■	4.10	#6-300 kcmil	#4-300 kcmil
175	MQJ2175 ■	3.00	MQJ3175 ■	4.10	#6-300 kcmil	#4-300 kcmil
200	MQJ2200 ■	3.00	MQJ3200 ■	4.10	#6-300 kcmil	#4-300 kcmil
225	MQJ2225 ■	3.00	MQJ3225 ■	4.10	#6-300 kcmil	#4-300 kcmil

Type MQH 22,000 AIC

060	MQJ260KH ■	3.00	MQJ360KH ■	4.10	#6-300 kcmil	#4-300 kcmil
070	MQJ270KH ■	3.00	MQJ370KH ■	4.10	#6-300 kcmil	#4-300 kcmil
080	MQJ280KH ■	3.00	MQJ380KH ■	4.10	#6-300 kcmil	#4-300 kcmil
090	MQJ290KH ■	3.00	MQJ390KH ■	4.10	#6-300 kcmil	#4-300 kcmil
100	MQJ2100KH ■	3.00	MQJ3100KH ■	4.10	#6-300 kcmil	#4-300 kcmil
110	MQJ2110KH ■	3.00	MQJ3110KH ■	4.10	#6-300 kcmil	#4-300 kcmil
125	MQJ2125KH ■	3.00	MQJ3125KH ■	4.10	#6-300 kcmil	#4-300 kcmil
150	MQJ2150KH ■	3.00	MQJ3150KH ■	4.10	#6-300 kcmil	#4-300 kcmil
175	MQJ2175KH ■	3.00	MQJ3175KH ■	4.10	#6-300 kcmil	#4-300 kcmil
200	MQJ2200KH ■	3.00	MQJ3200KH ■	4.10	#6-300 kcmil	#4-300 kcmil
225	MQJ2225KH ■	3.00	MQJ3225KH ■	4.10	#6-300 kcmil	#4-300 kcmil

Type MQL 42,000 AIC

60	MQJ260KL ■	3.00	MQJ360KL ■	4.10	#6-300 kcmil	#4-300 kcmil
070	MQJ270KL ■	3.00	MQJ370KL ■	4.10	#6-300 kcmil	#4-300 kcmil
080	MQJ280KL ■	3.00	MQJ380KL ■	4.10	#6-300 kcmil	#4-300 kcmil
090	MQJ290KL ■	3.00	MQJ390KL ■	4.10	#6-300 kcmil	#4-300 kcmil
100	MQJ2100KL ■	3.00	MQJ3100KL ■	4.10	#6-300 kcmil	#4-300 kcmil
110	MQJ2110KL ■	3.00	MQJ3110KL ■	4.10	#6-300 kcmil	#4-300 kcmil
125	MQJ2125KL ■	3.00	MQJ3125KL ■	4.10	#6-300 kcmil	#4-300 kcmil
150	MQJ2150KL ■	3.00	MQJ3150KL ■	4.10	#6-300 kcmil	#4-300 kcmil
175	MQJ2175KL ■	3.00	MQJ3175KL ■	4.10	#6-300 kcmil	#4-300 kcmil
200	MQJ2200KL ■	3.00	MQJ3200KL ■	4.10	#6-300 kcmil	#4-300 kcmil
225	MQJ2225KL ■	3.00	MQJ3225KL ■	4.10	#6-300 kcmil	#4-300 kcmil

Type QJ2/QJH2/QJ2H

Continuous Current Rating @ 40° C	Type QJ2	Type QJH2	Type QJ2H
	10,000A IR	22,000A IR	65,000A IR
	Catalog Number	Catalog Number	Catalog Number

2-Pole (240V AC)

60	QJ2060 ■	QJ2060KH ■	QJ2060KL ■
70	QJ2070 ■	QJ2070KH ■	QJ2070KL ■
80	QJ2080 ■	QJ2080KH ■	QJ2080KL ■
90	QJ2090 ■	QJ2090KH ■	QJ2090KL ■
100	QJ2100 ■	QJ2100KH ■	QJ2100KL ■
110	QJ2110 ■	QJ2110KH ■	QJ2110KL ■
125	QJ2125	QJ2125KH	QJ2125KL
150	QJ2150	QJ2150KH	QJ2150KL
175	QJ2175	QJ2175KH ■	QJ2175KL ■
200	QJ2200	QJ2200KH	QJ2200KL
225	QJ2225	QJ2225KH	QJ2225KL

3-Pole (240V AC)

60	QJ3060	QJ3060KH ■	QJ3060KL ■
70	QJ3070	QJ3070KH ■	QJ3070KL ■
80	QJ3080 ■	QJ3080KH ■	QJ3080KL ■
90	QJ3090 ■	QJ3090KH ■	QJ3090KL ■
100	QJ3100	QJ3100KH	QJ3100KL
110	QJ3110	QJ3110KH	QJ3110KL ■
125	QJ3125	QJ3125KH	QJ3125KL
150	QJ3150	QJ3150KH	QJ3150KL
175	QJ3175	QJ3175KH	QJ3175KL
200	QJ3200	QJ3200KH	QJ3200KL
225	QJ3225	QJ3225KH	QJ3225KL

■ Built to order. Allow 2-3 weeks for delivery.

Circuit Breakers

Line Diagrams

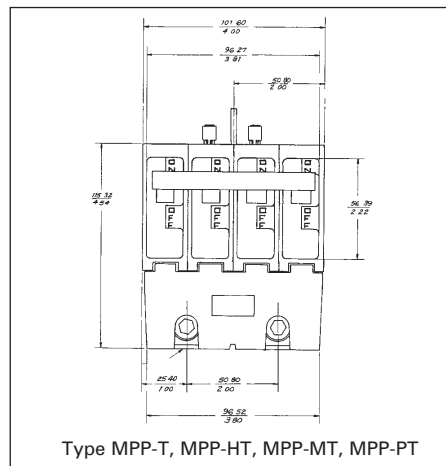
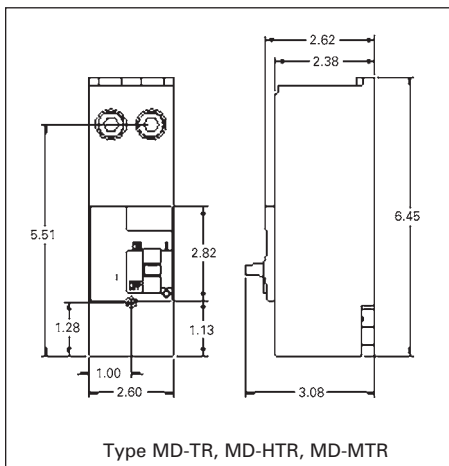
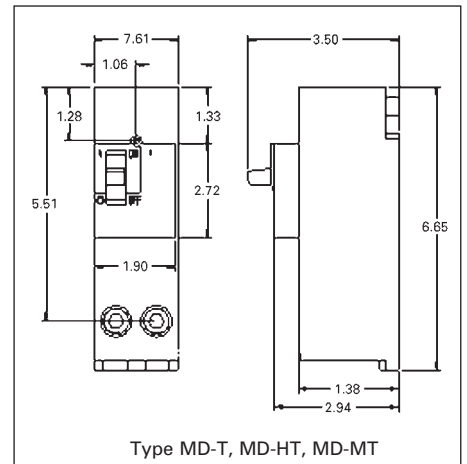
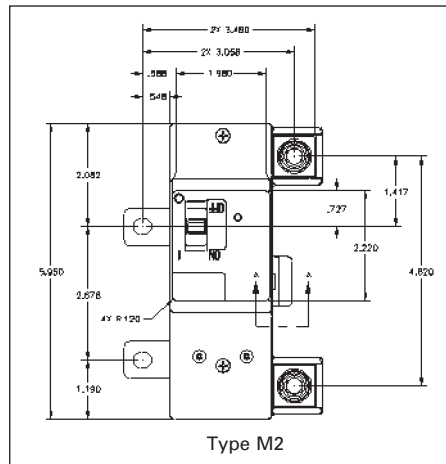
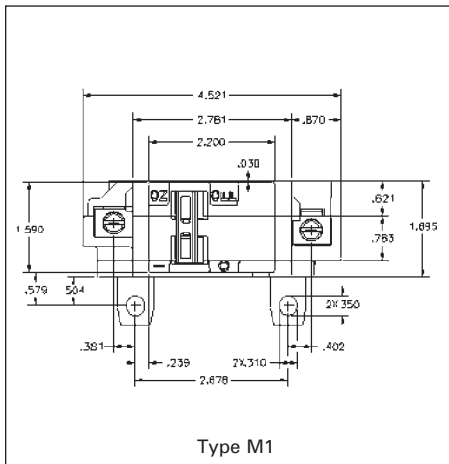
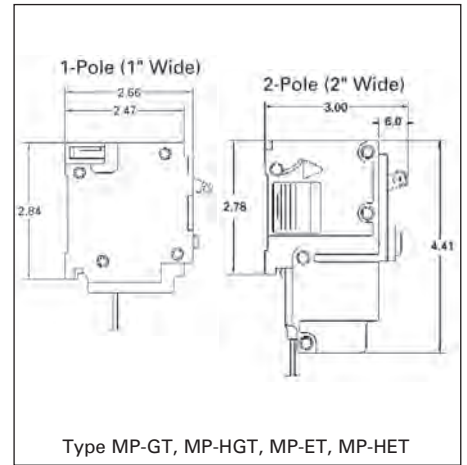
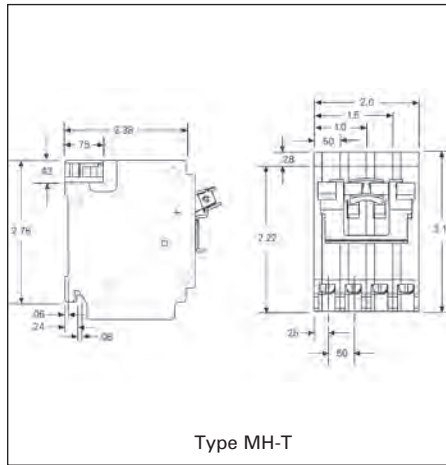
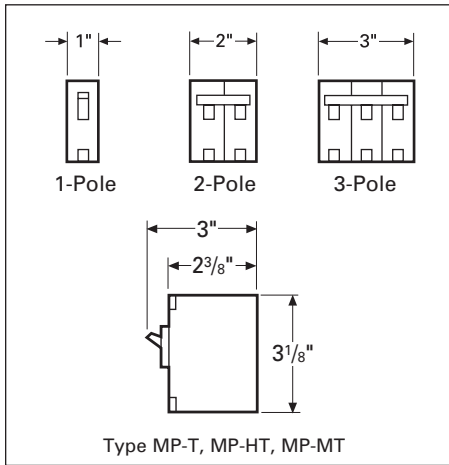

©All standard circuit breakers are calibrated to 40°C maximum ambient application.

Circuit Breakers

• Revised •
06/13/14

MURRAY

Lug Data

Circuit Breaker Type	Circuit Breaker Ampere Rating	Cables Per Connector	Connector Wire Range
	LOAD SIDE		
MP-T, MP-HT, MP-MT	7	2	#18-#14 CU
	10	2	#16-#14 CU
	15-35	1 1	#14-#16 AWG Cu #14-#16 AWG Al
	40-50	1 1	#8-#6 AWG Cu #8-#4 AWG Al
	55-125	1 1	#8-#2/0 Cu #8-#2/0 Al
MH-T	15-35	1 1	#14-#8 AWG Cu #12-#8 AWG Al
	40	1	#8 AWG CU-AL
	40-50	1 1	#8-#6 AWG Cu #8-#4 AWG Al
MP-GT, MP-HGT, MP-ET, MP-HET BLF, BLHF, BLE, BLEH	15-30	1 1	#14-#10 AWG Cu #12-#8 AWG Al
	40-60	1 1	#8-#6 AWG Cu #8-#4 AWG Al
MP-AT2, MP-HAT, BAF, BAFH	15-20	1 1	#14-#12 AWG Cu #12-#10 AWG Al
MSQ	15-20	2	#14-#8 AWG Cu Only
	15-20	1 1	#14-#12 AWG Cu #12-#10 AWG Al
	25-35	1 1	#10-#8 AWG Cu #10-#6 AWG Al
	40-60	1 1	#8-#6 AWG Cu #8-#4 AWG Al
MD-T, MD-HT, MD-MT, MD-PT, MD-TR, MD-HTR, MD-MTR, MD-PTR	150-200	1	#1-300kcmil Cu-Al
M1	100	1	#4-3/0 AWG Cu #4-3/0 AWG Al
		1	#4-3/0 AWG Cu #4-3/0 AWG Al
	125	1	#4-3/0 AWG Cu-Al
M2	150	1	#1-300kcmil Cu-Al
	200	1	#1-300kcmil Cu-Al
	225	1	#1-300kcmil Cu-Al
MPP-T, MPP-HT, MPP-MT, MPP-PT	125	1 1	#1 AWG Cu #2/0 AWG Al
	150	1 1	#1/0 AWG Cu #3/0 AWG Al
	175	1 1	#2/0 AWG Cu #4/0 AWG Al
	200	1 1	#3/0 AWG Cu 250kcmil AWG Al
	225	1 1	#4/0 AWG Cu 300kcmil AWG Al
MQ, MQH, MQL	60-225	1	#6-300kcmil Cu #4-300kcmil Al

MURRAY
3

Circuit Breakers