

Product family features

- Can be used in conjunction with the following dimmer(s), switch(es), sensor(s), and accessories: Maestro®, Maestro IR®, Maestro Wireless®, Caséta® Wireless, Pico® wireless, Diva®, Skylark Contour® and Skylark® controls, and Claro® and Satin Colors® accessories
- All Lutron wallplates are screwless, seamless, and have no visible hardware; the front plate securely snaps into the alignment adapter plate
- Full line of wiring devices in Designer style opening
- Blank inserts available for Gloss (DV-BI-) and Satin Colors (SC-BI-)

Ganging and derating

- Designer wallplates use standard ganging
- Requires fins to be removed from dimmers for proper spacing (“Fins Broken” ganging)
- May require derating (i.e., reduction of dimmer capacity due to fin removal), see Derating Tables

Available finishes

Use **BOLD** color code in model number (Example: SC-1-**PL**)

Gloss finishes



WH
White



LA
Light Almond



AL
Almond



IV
Ivory



GR
Gray



BR
Brown



BL
Black

Satin Colors® finishes



SW
Snow



LS
Limestone



BI
Biscuit



ES
Eggshell



PD
Palladium



TP
Taupe



ST
Stone



BG
Bluestone



PL
Plum



SG
Sea Glass



TQ
Turquoise



GS
Goldstone



DS
Desert Stone



GB
Greenbriar

Metal finishes*



MS
Mocha Stone



TC
Terracotta

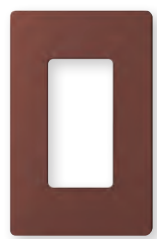

SI
Sienna



HT
Hot



MR
Merlot



MN
Midnight



SS
Stainless Steel

*Stainless Steel finish wallplates include black plastic trim/adaptor, visible from side. Match with separate Black (BL) or Midnight (MN) controls and accessories.

Receptacles



- Tamper resistant receptacles include tamper resistant shutter mechanism (shutters are white)
- Wallplate sold separately

Receptacles

15A 125V	CAR-15- XX ¹
15A 125V	SCR-15- XX ²
20A 125V	SCR-20- XX ²

Tamper-resistant receptacles

15A 125V	CARS-15-TR- XX ¹
15A 125V	SCRS-15-TR- XX ²
20A 125V	SCRS-20-TR- XX ²

USB receptacles



- Includes two USB ports
- Ports are rated for a minimum of 10,000 insertions and removals
- Wallplate sold separately

Tamper-resistant USB receptacles

15A 125V	CAR-15-UBTR- XX ¹
15A 125V	SCR-15-UBTR- XX ²

Important notes

- Receptacles and plugs for dimming use are UL listed for use with all Lutron wallbox dimmers included in this catalog.
- If there is only one electrical feed to the receptacle, then the duplex DFDU must be used.
- If the hot and dimmed hot feeds to the split duplex HFDU are supplied from different circuits or split-wired with separate switch-legs, a means to simultaneously disconnect these circuits must be provided at the panel board where they originate (NEC 210.7(C) 2002 Edition). A 2-pole circuit breaker or two single-pole circuit breakers with an approved handle tie can be used to accomplish this simultaneous disconnect. Feed-through dimming panels, which are those without breakers, are recommended when using the HFDU.

XX¹: Gloss color codes
XX²: Satin Colors® codes

Designer | Claro® and Satin Colors® Wallplates & Accessories

Accessories

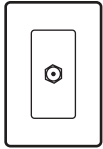

Cable Jack
CA-CJ-
SC-CJ-

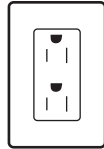

Receptacle
CAR-15-
SCR-15-
NCR-20-

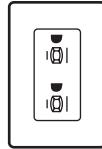

Dual Dimming, Tamper-resistant Receptacle
CAR-15-DDTR-
SCR-15-DDTR-
CAR-20-DDTR-
SCR-20-DDTR-

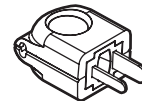

Replacement Dimming Plug
RP-FDU-10-

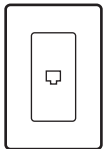

Telephone Jack
CA-PJ-
SC-PJ-

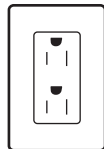

Tamper-resistant Receptacle
CARS-15-TR-
SCRS-15-TR-
SCRS-20-TR-

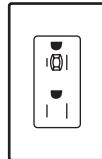

Half Dimming, Tamper-resistant Receptacle
CAR-15-HDTR-
SCR-15-HDTR-
CAR-20-HDTR-
SCR-20-HDTR-

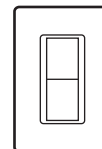

General Purpose Switch
CA-1PS-
SC-1PS-
CA-3PS-
SC-3PS-
CA-4PS-
SC-4PS-

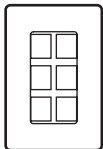

Field Customizable 6-port Frame
CA-6PF-
SC-6PF-

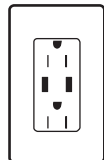

Tamper-resistant USB Receptacle
CAR-15-UBTR-
SCR-15-UBTR-

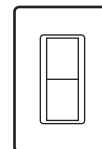

General Purpose Switch with Locator Light
CA-1PSNL-
SC-1PSNL-
CA-3PSNL-
SC-3PSNL-
CA-4PSNL-
SC-4PSNL-

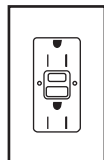

Tamper-resistant, Self-testing GFCI Receptacle
CAR-15-GFST-
SCR-15-GFST
SCR-20-GFST-

Wiring diagram #29

Telephone jack wiring, 8-conductor

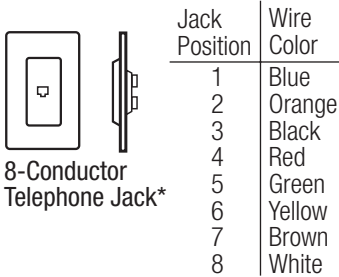

8-Conductor Telephone Jack*

*Accepts most 4- or 6-conductor jacks

Wiring diagram #30

Receptacle wiring

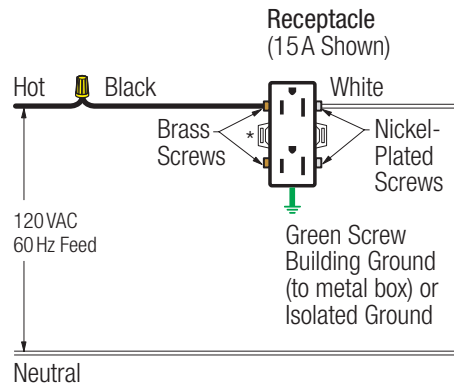

*For split circuit wiring, break off tab on brass side only

Wiring diagram #31

GFCI receptacle wiring

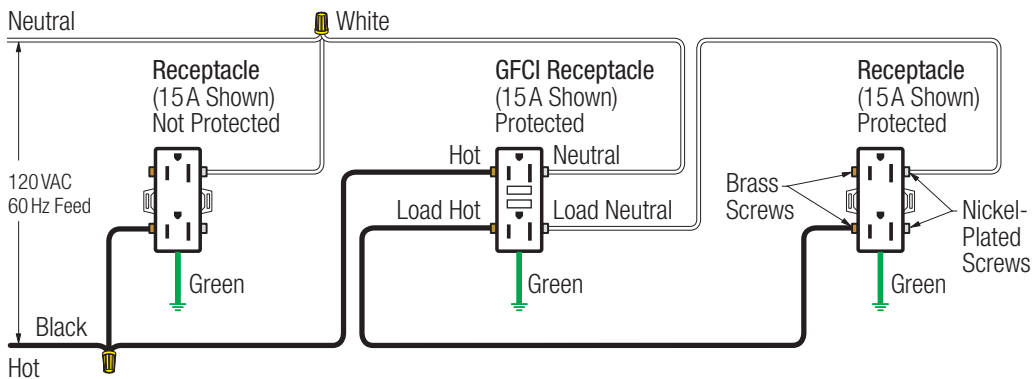

Wiring diagram #32

Single-pole wiring of 3-way, 3-wire control

